

ORO OR 1

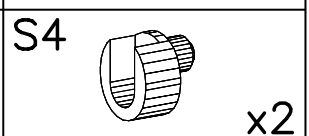

1

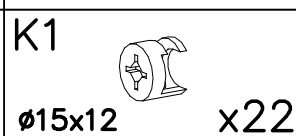
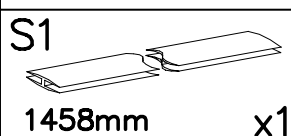
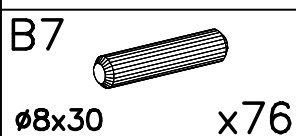
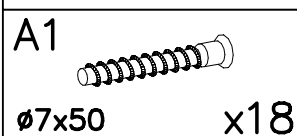
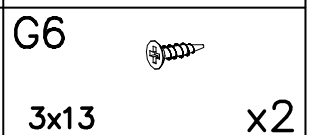
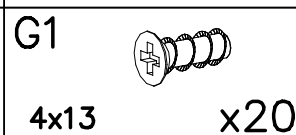
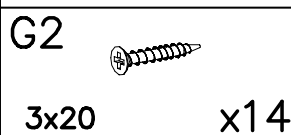
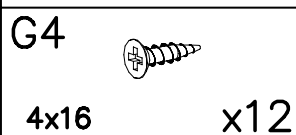
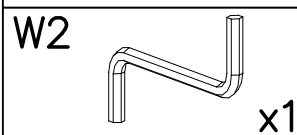
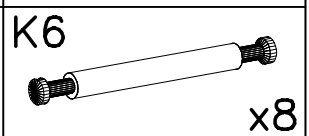
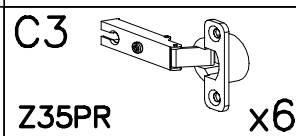
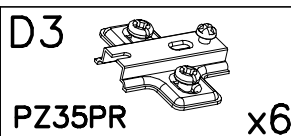
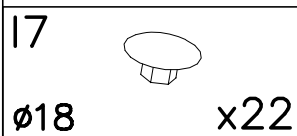
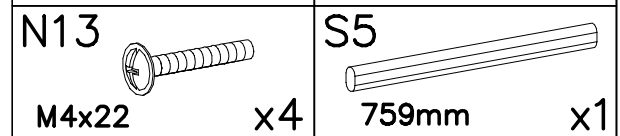
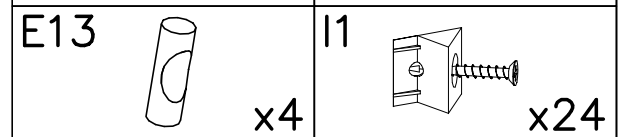
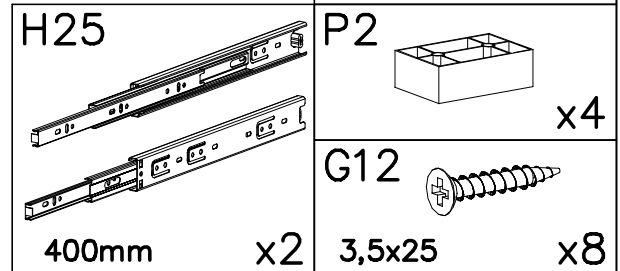
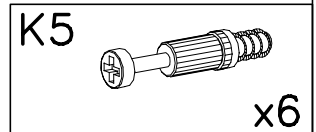
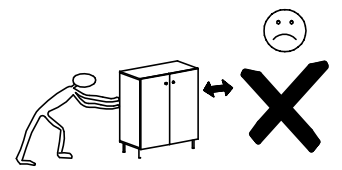
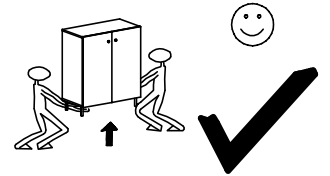
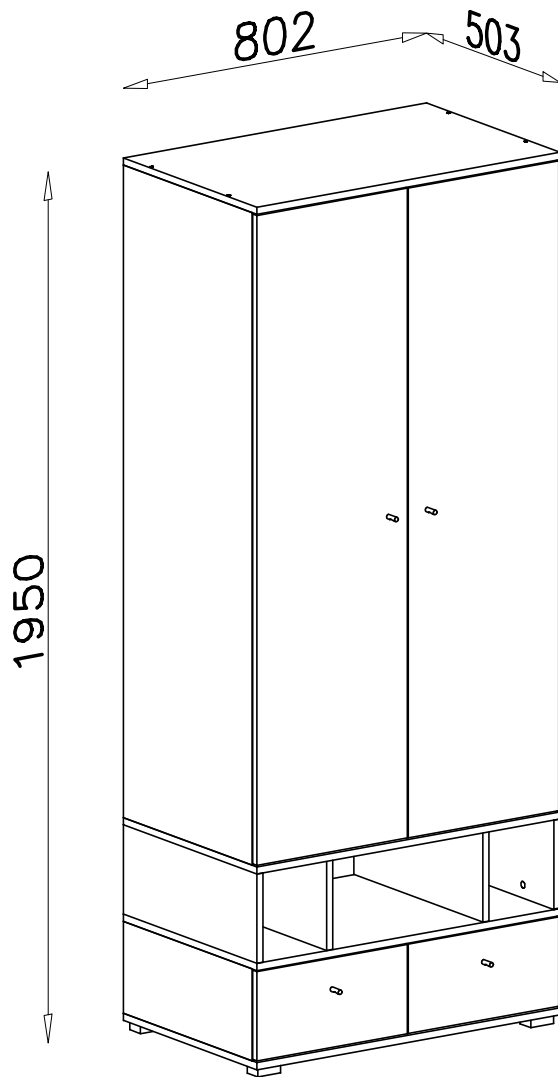
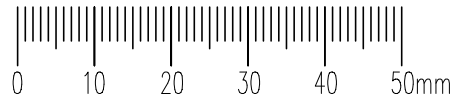
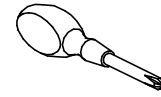
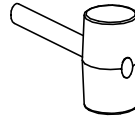
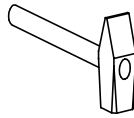
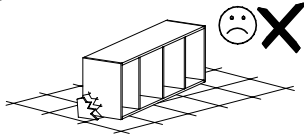
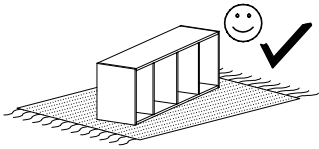
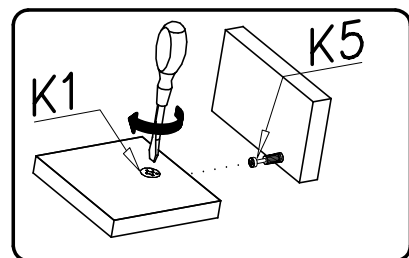
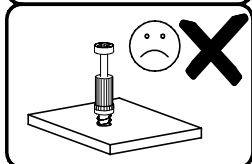
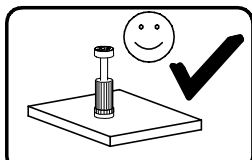
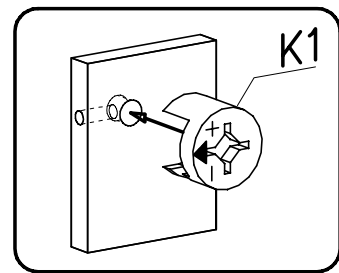
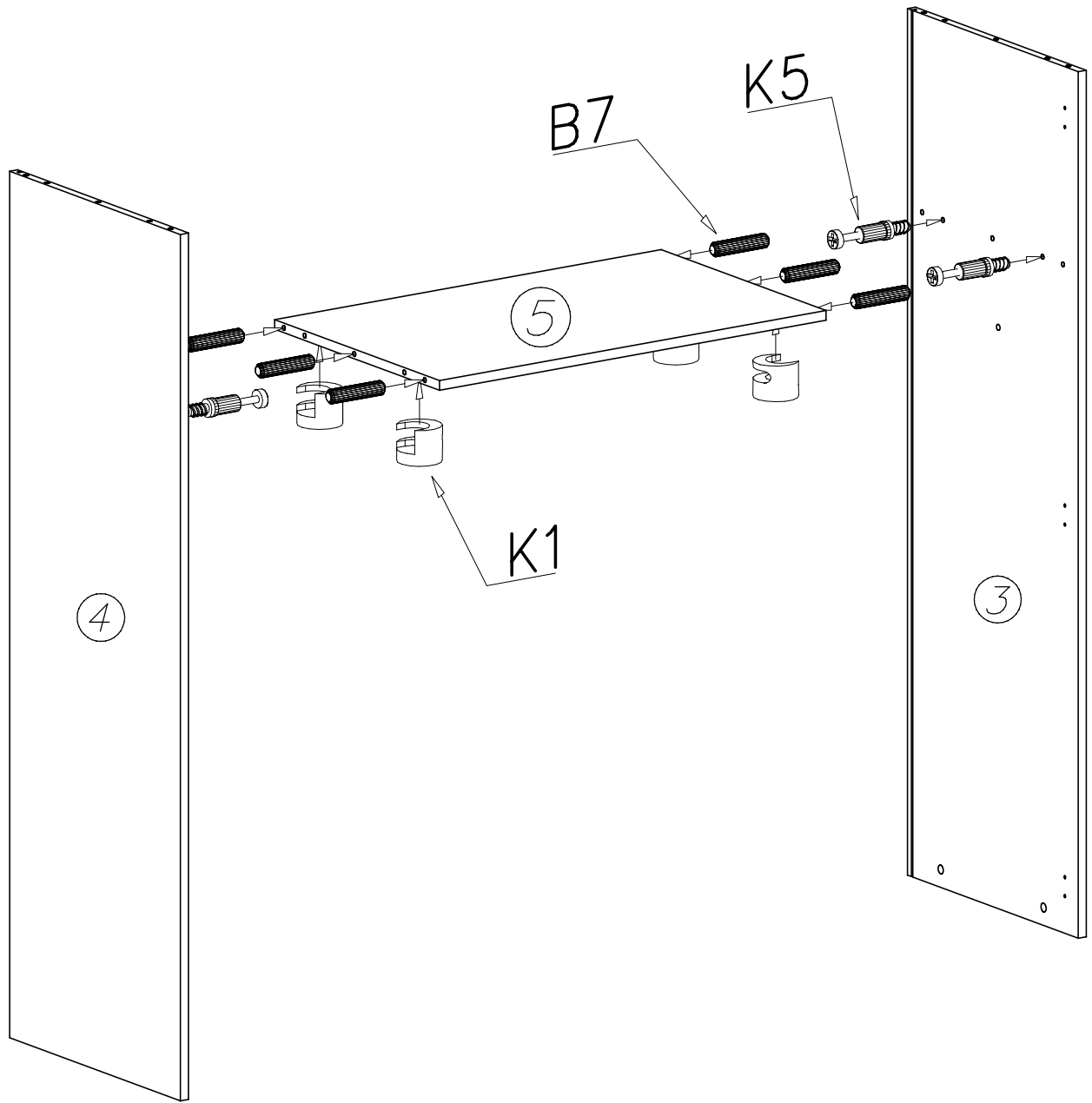

II

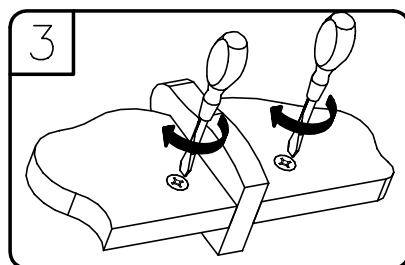
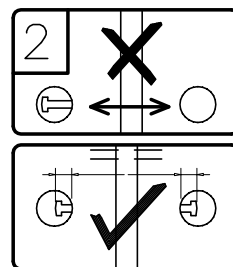
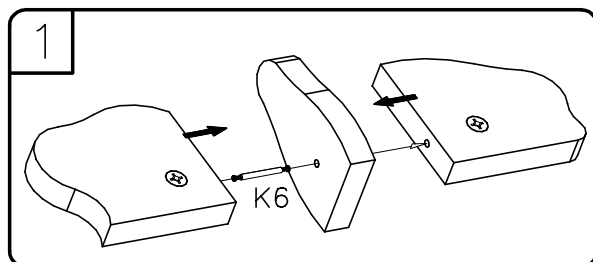
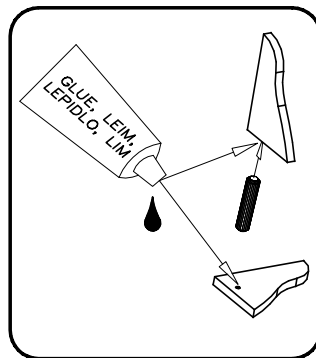
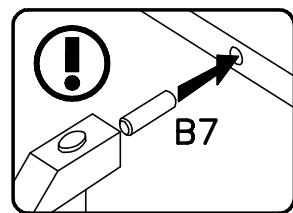
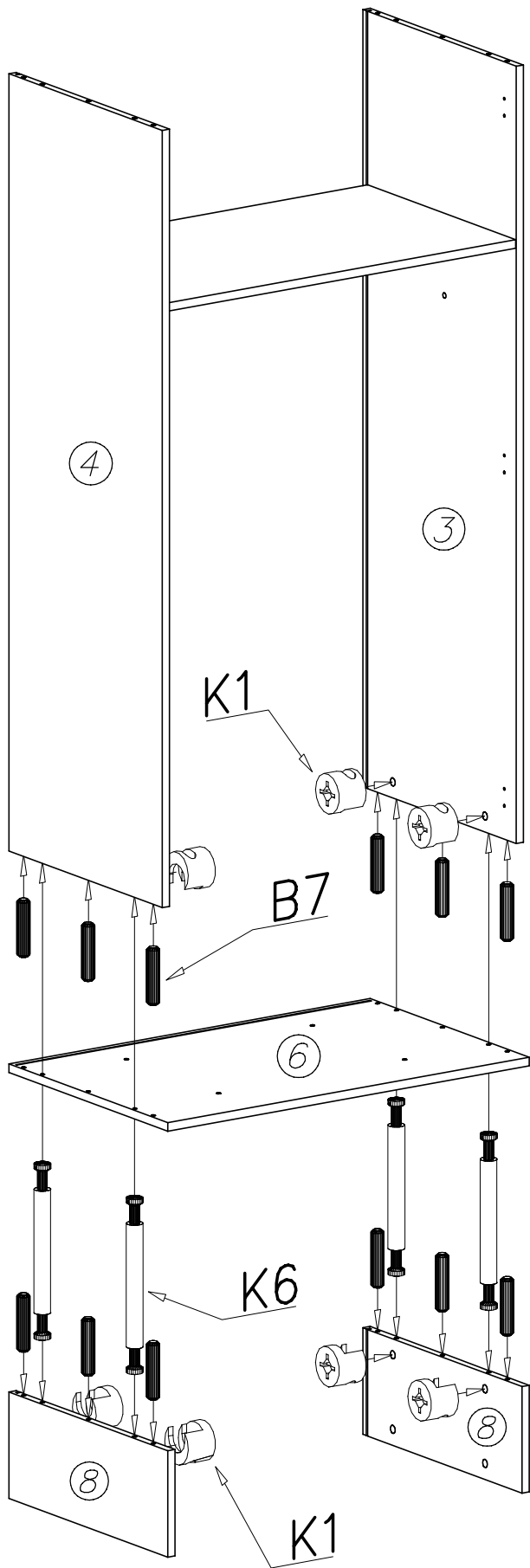

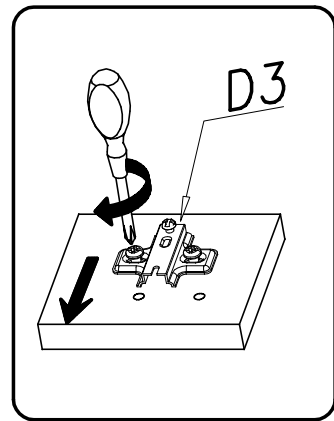
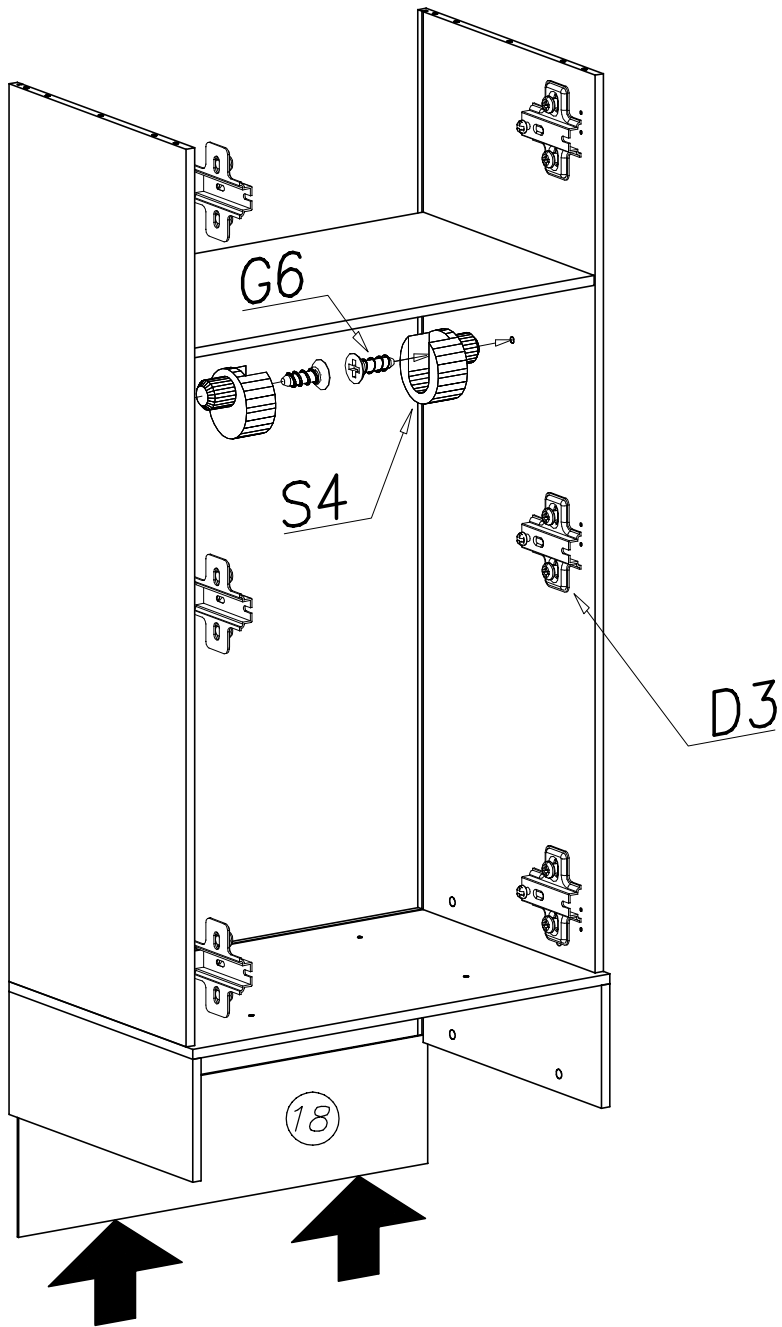

IV

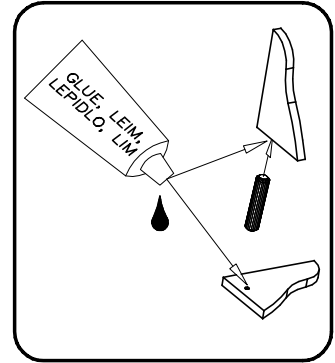
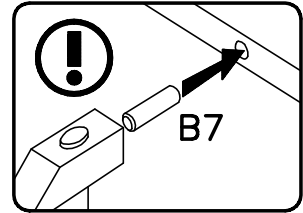
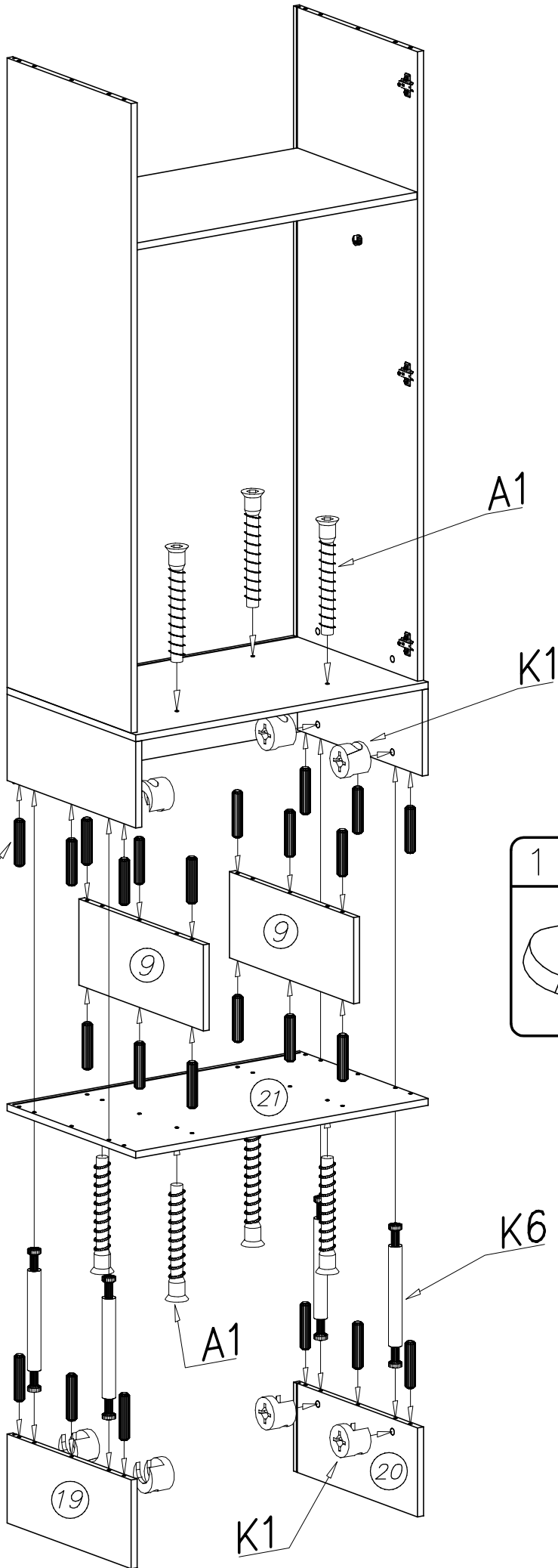

B7

A1

K1

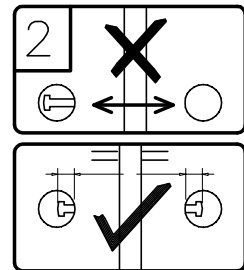
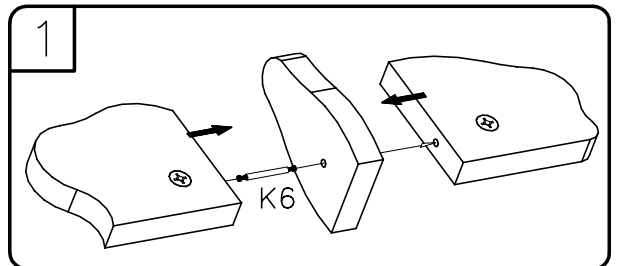

K6

A1

19

K1

20

21

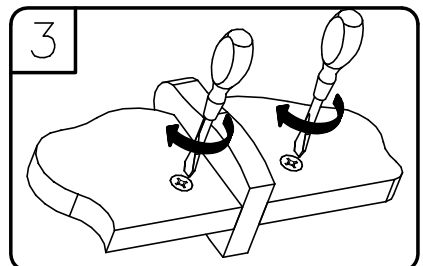

3

V

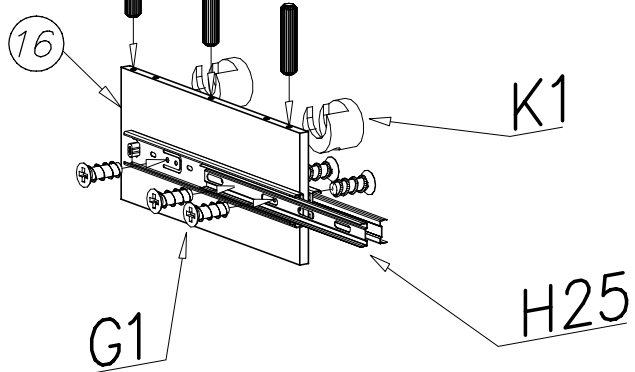
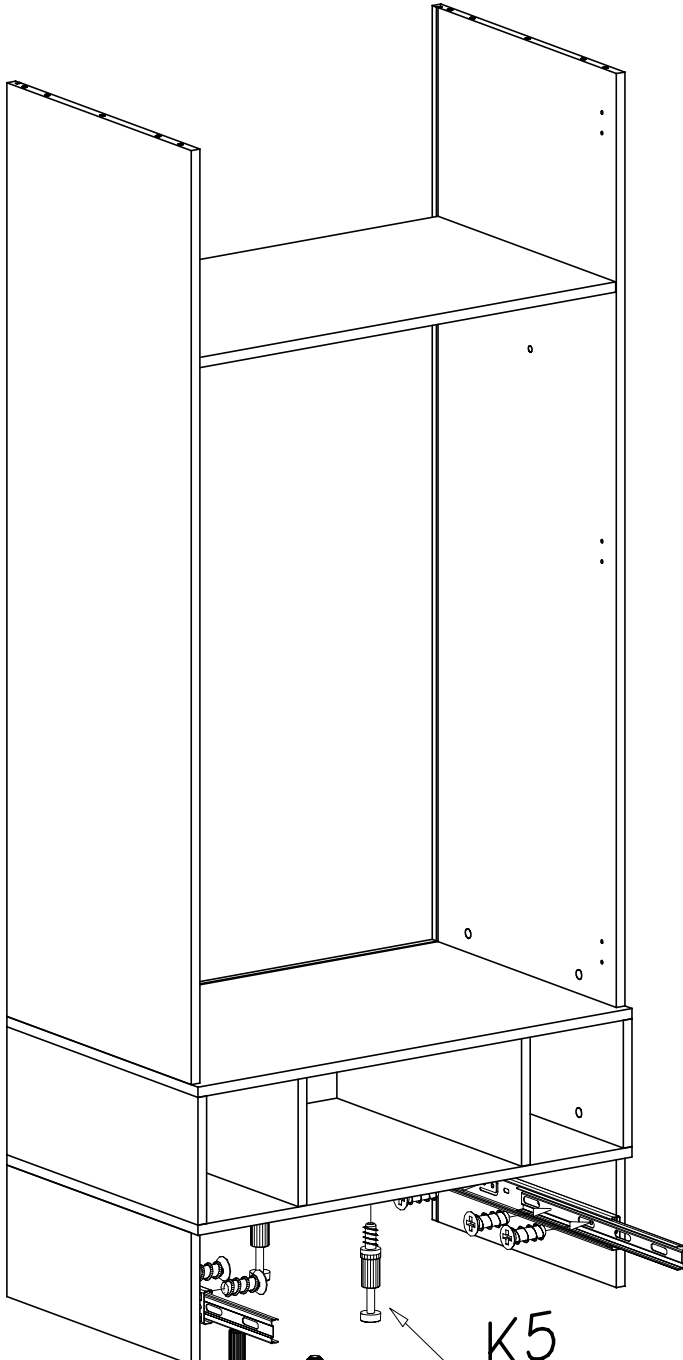

B

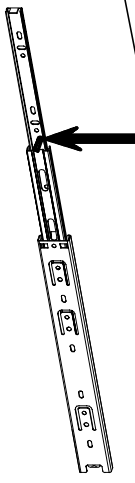

A

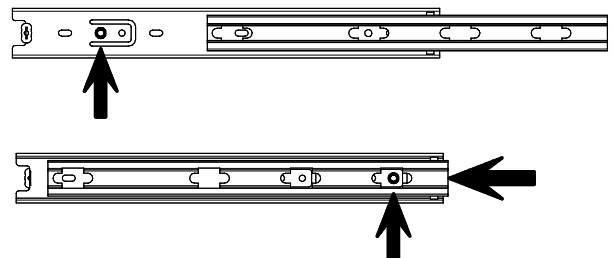
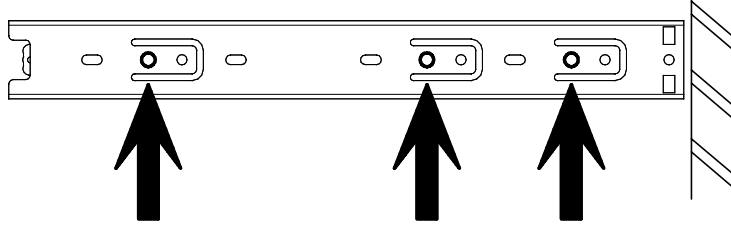
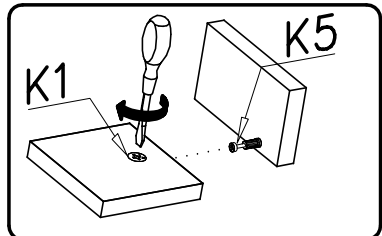
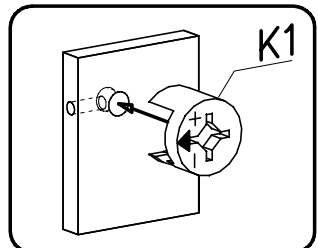
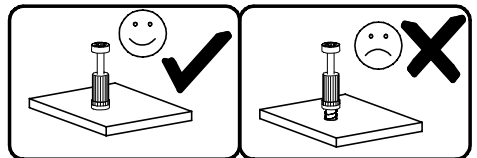
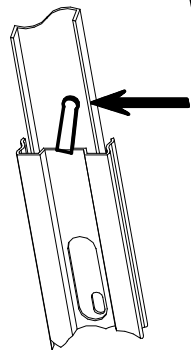
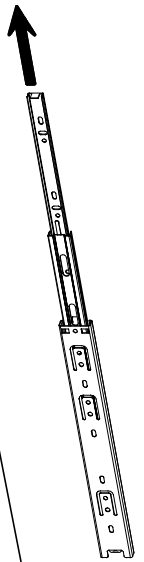

VI

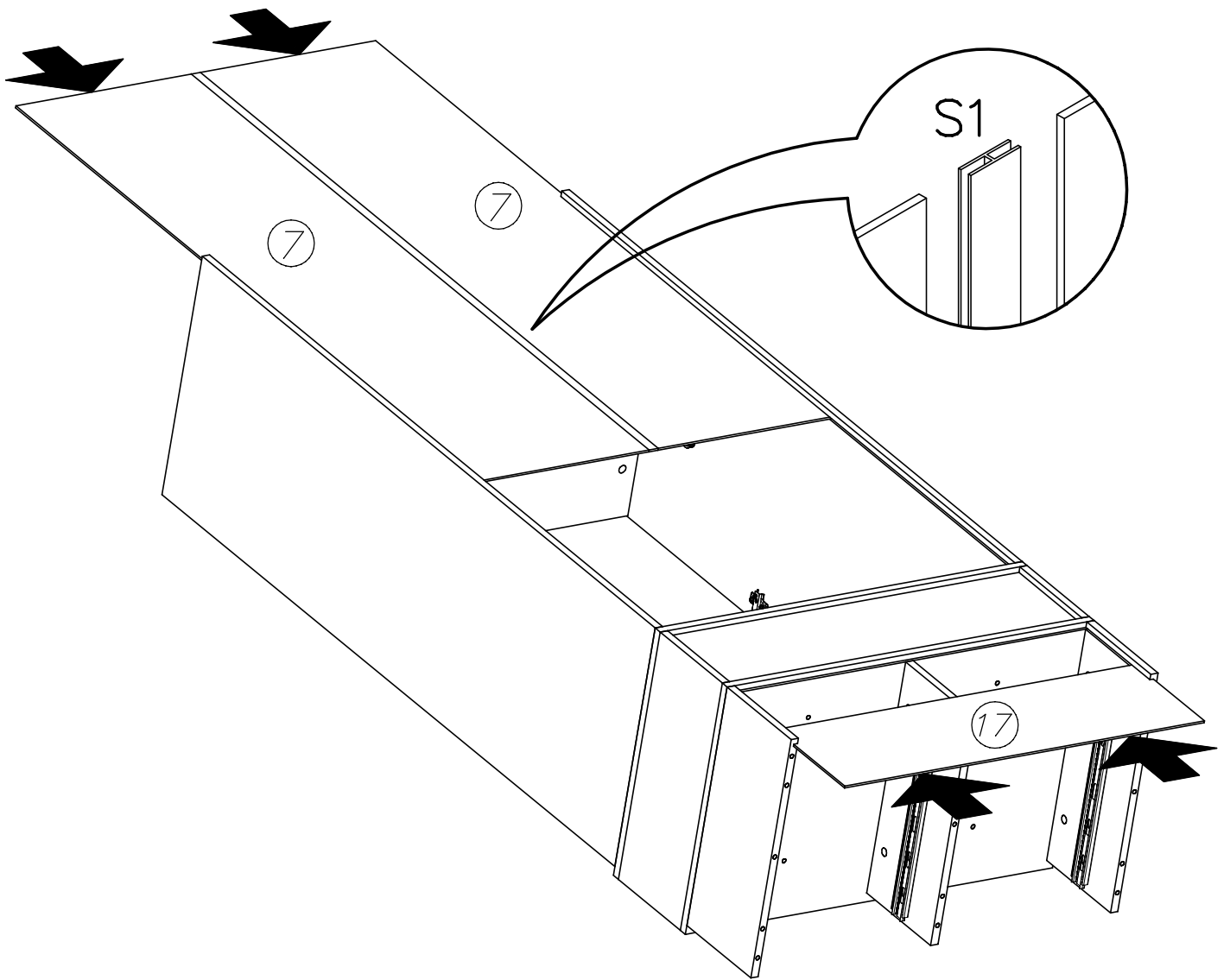

VIII

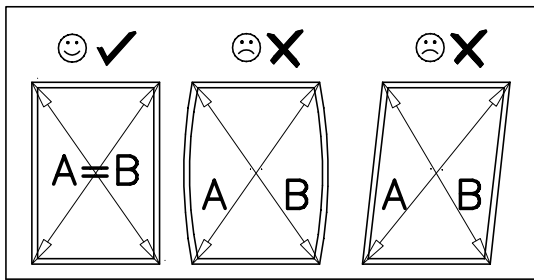

A=B

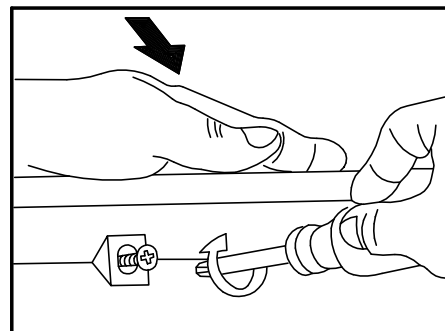
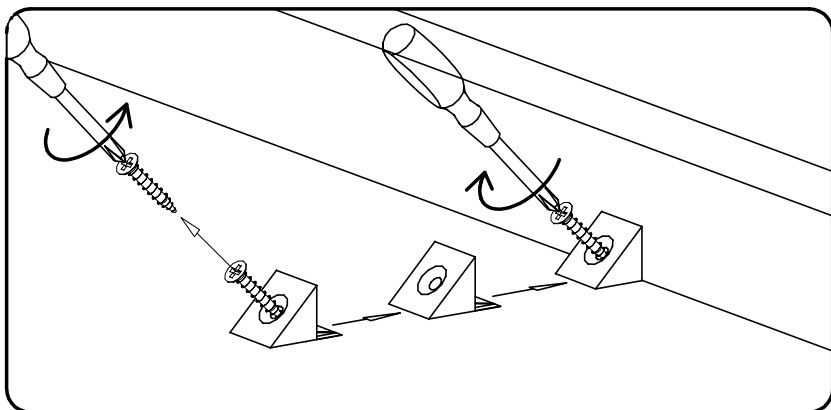
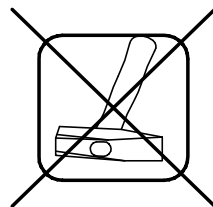
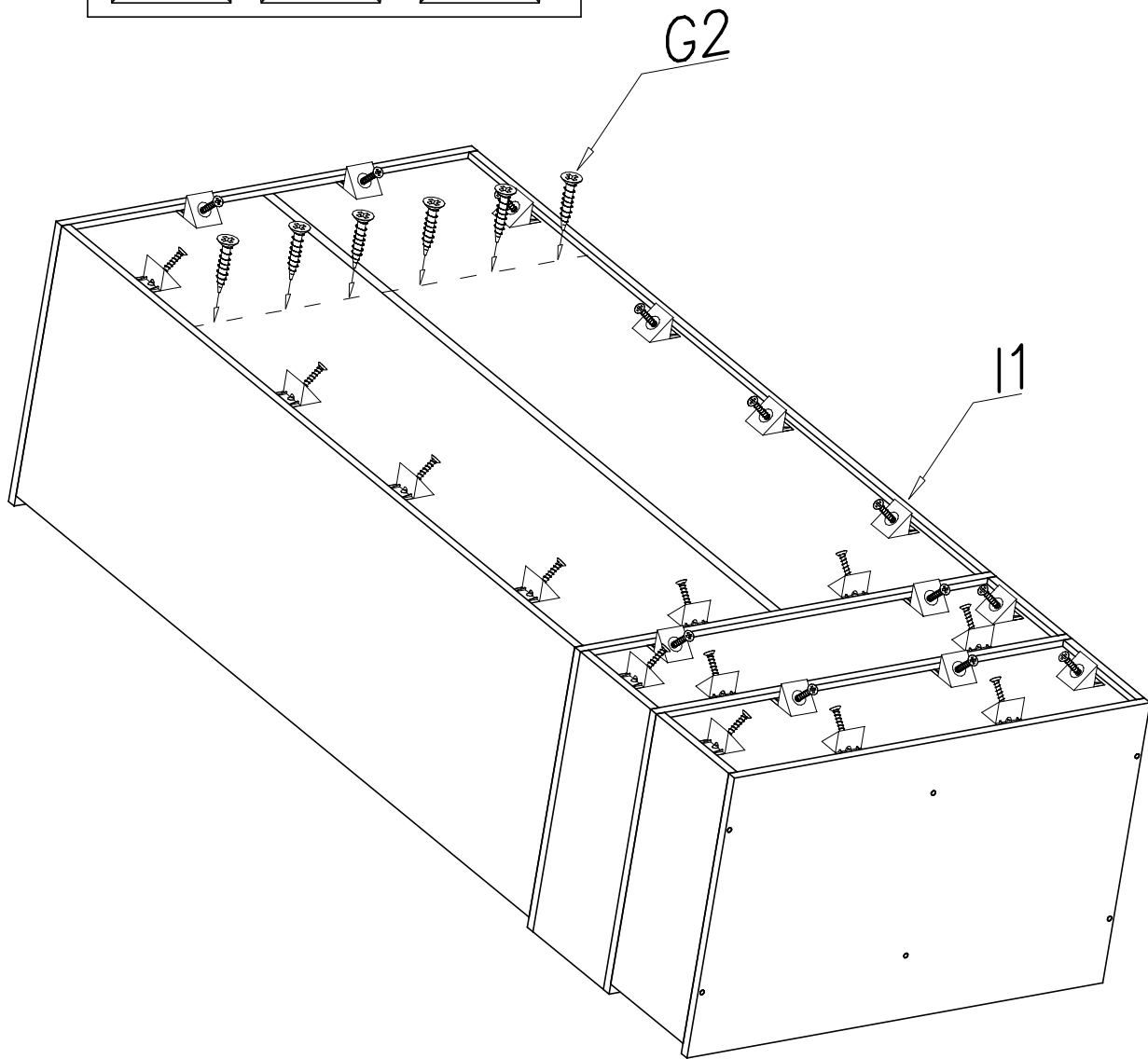
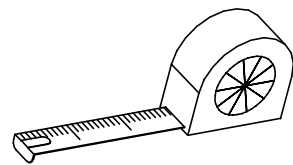

IX

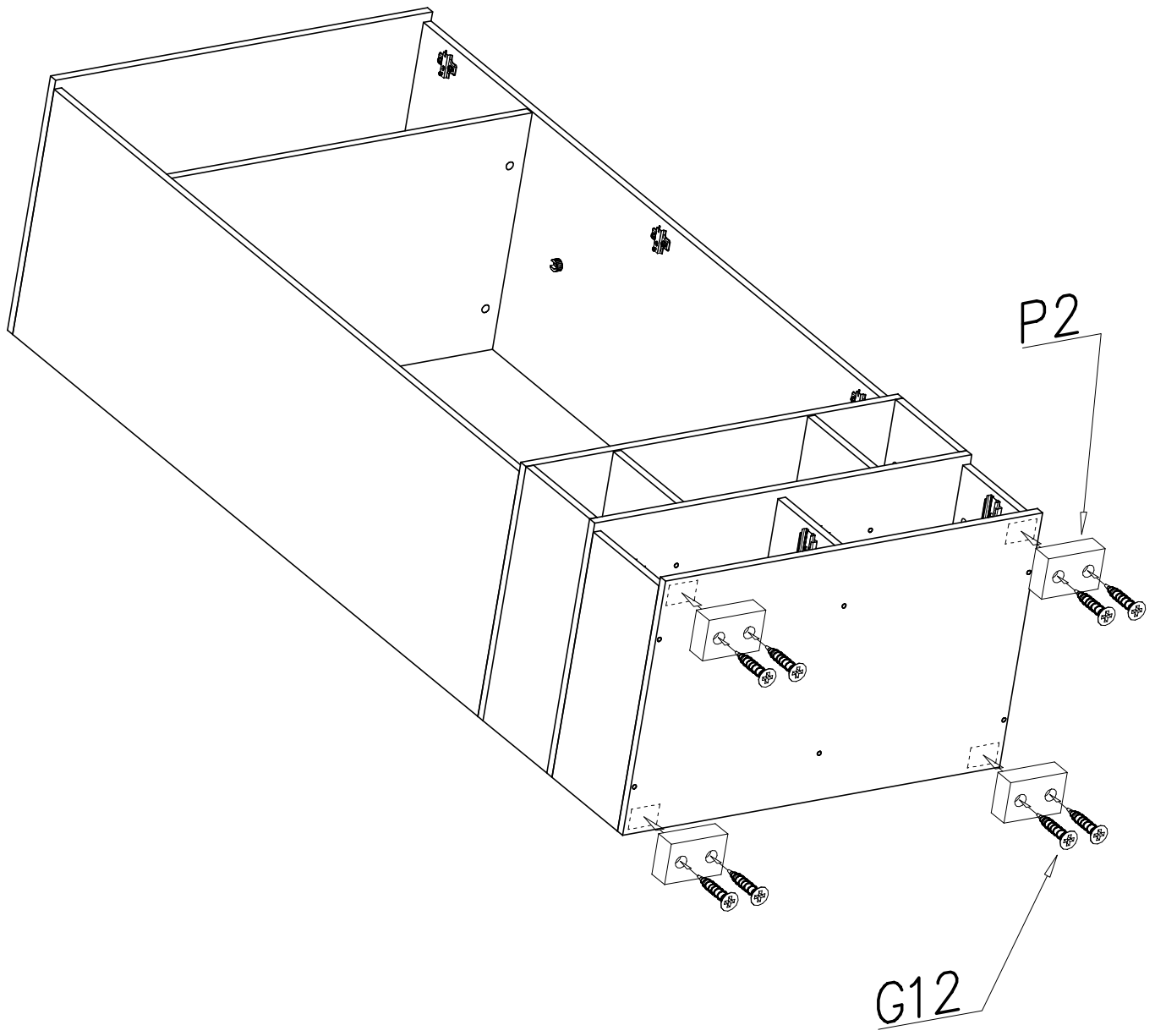

(X)

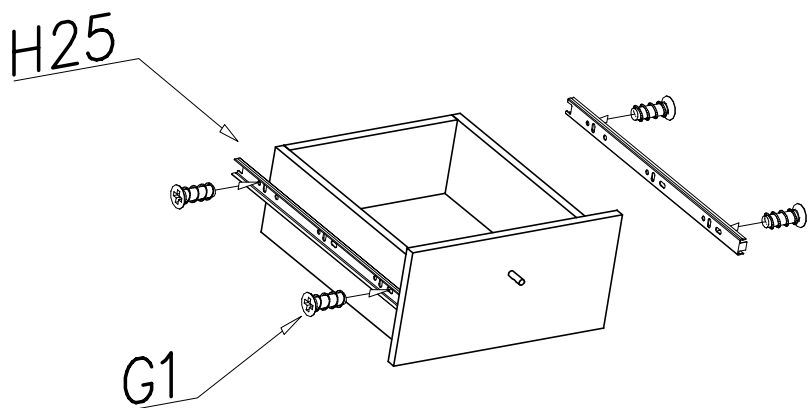
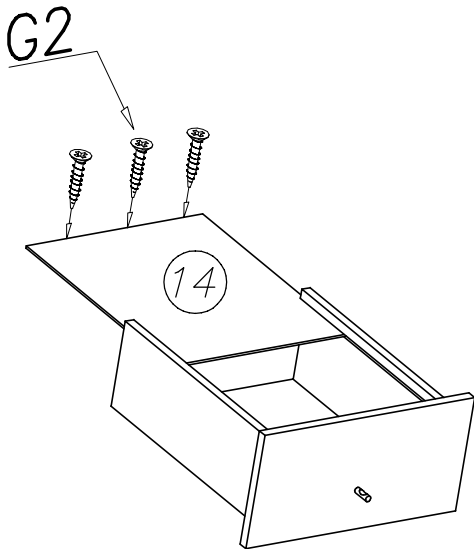
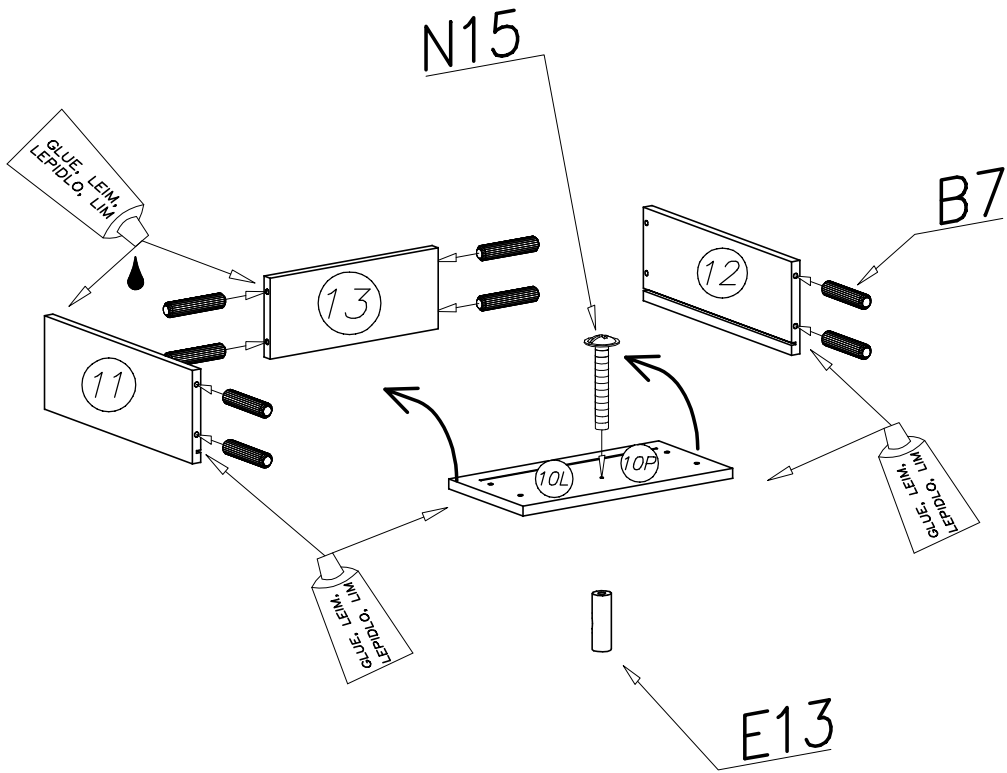

XI

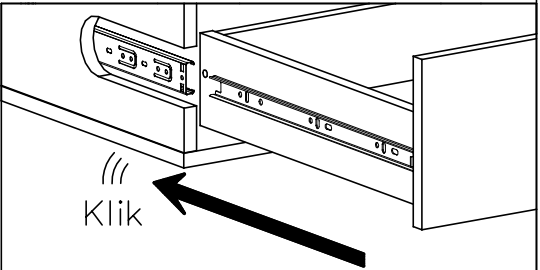
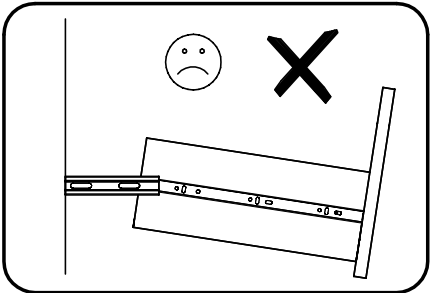
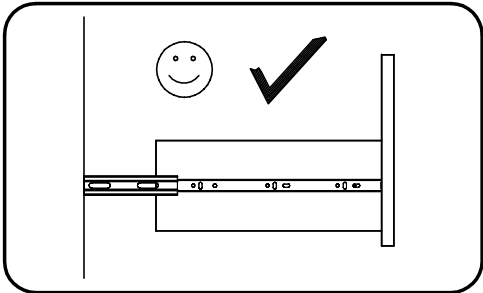
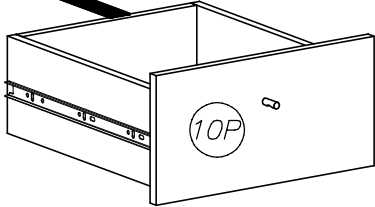
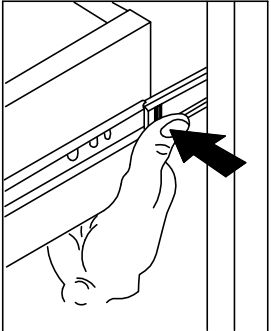
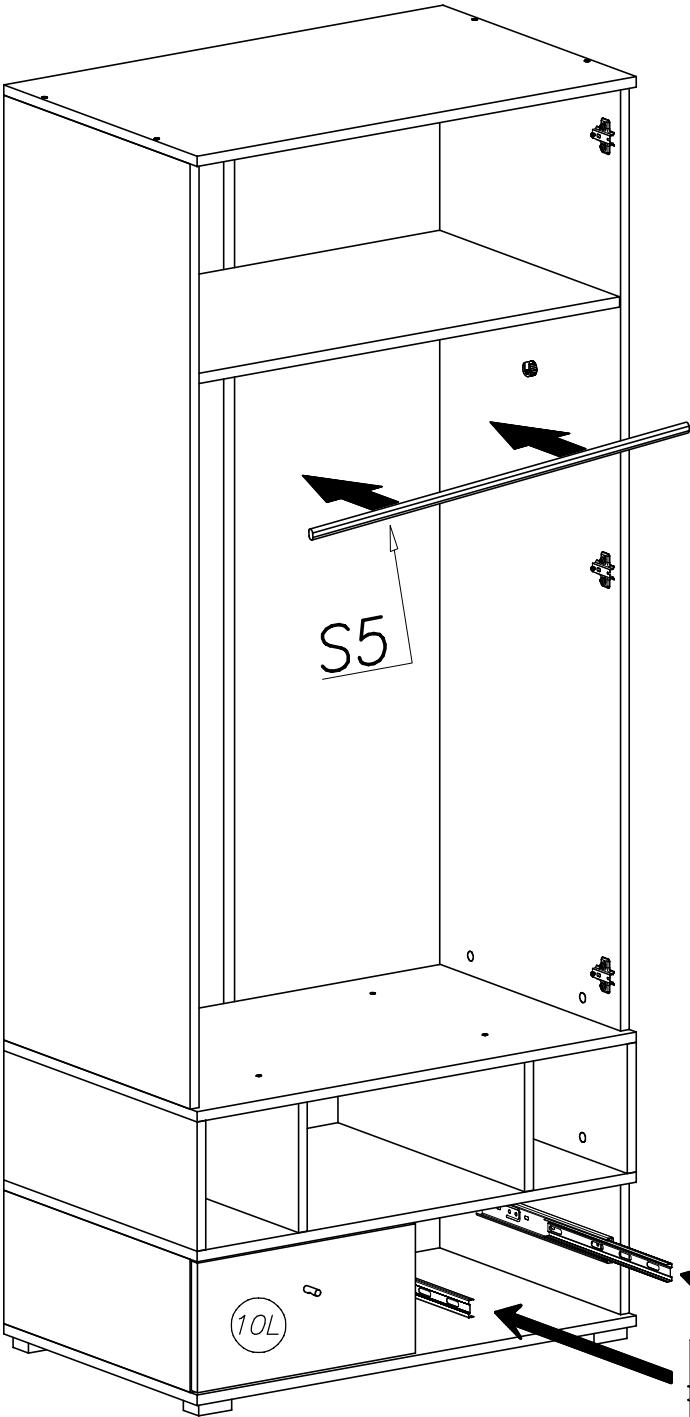
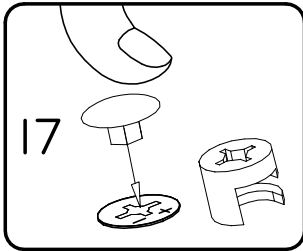

XII

