

# ZOYA ZY 2

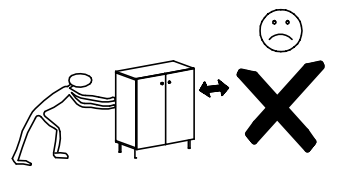
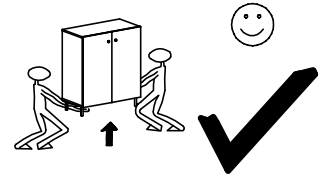
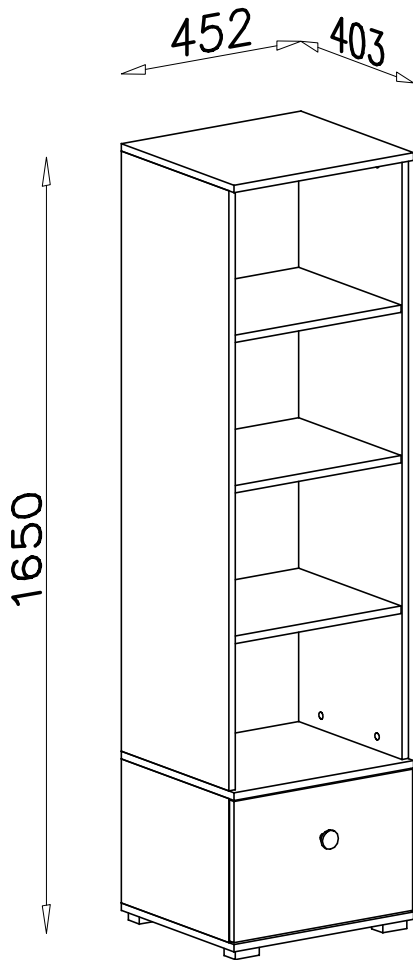
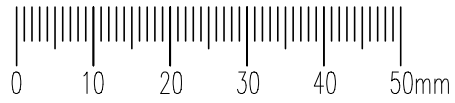
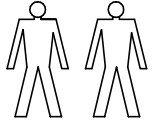
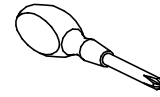
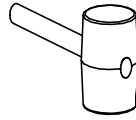
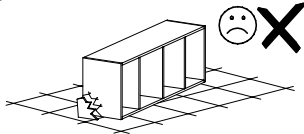
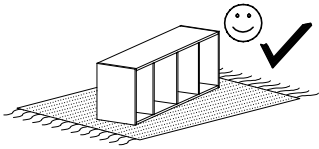

**I7**  
ø18 x16

**N15**  
M4x25 x1

**E35**  
x1

**H24**  
350mm x1

**G1**  
4x13 x10

**P2**  
x4

**G12**  
3,5x25 x8

**A1**  
ø7x50 x4

**B7**  
ø8x30 x38

**K5**  
x8

**F1**  
x8

**K1**  
ø15x12 x16

**I1**  
x12

**K6**  
x4

**W1**  
GLUE, LEIM, LEPIDLO, LIM x2

**W2**  
x1

**G2**  
3x20 x6

I

A

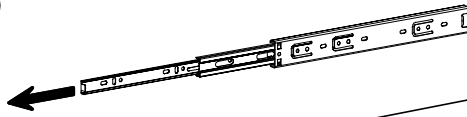

B

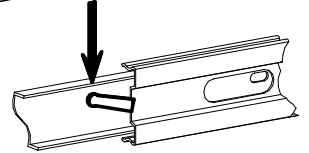
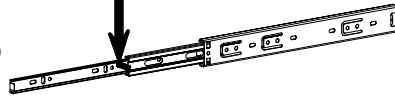

H24

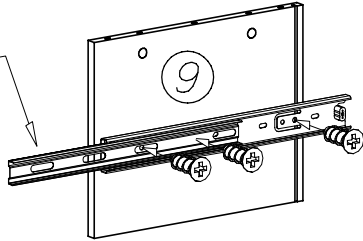

G1

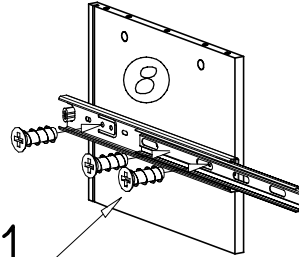

H24

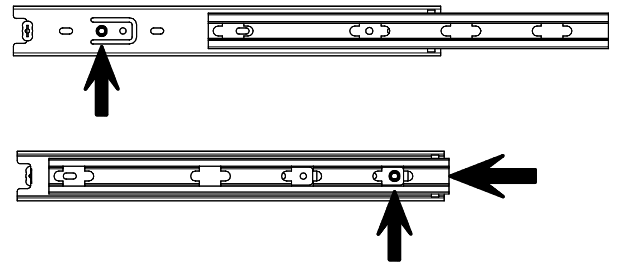
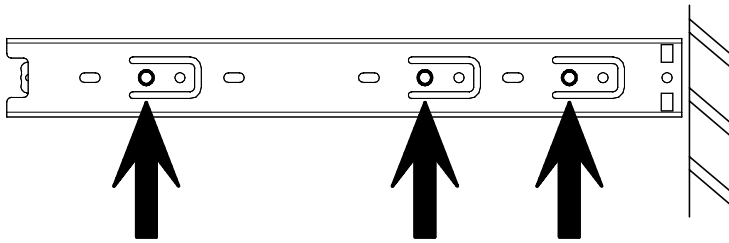

II

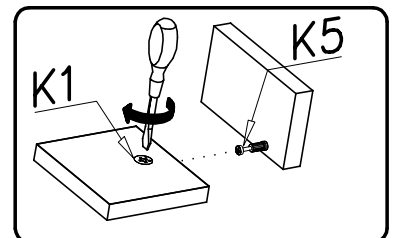
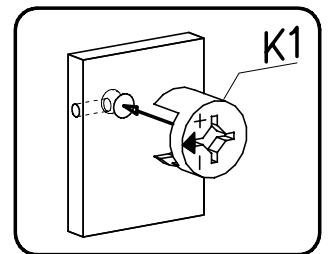
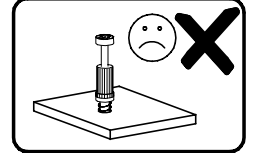
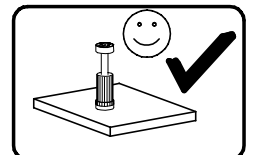
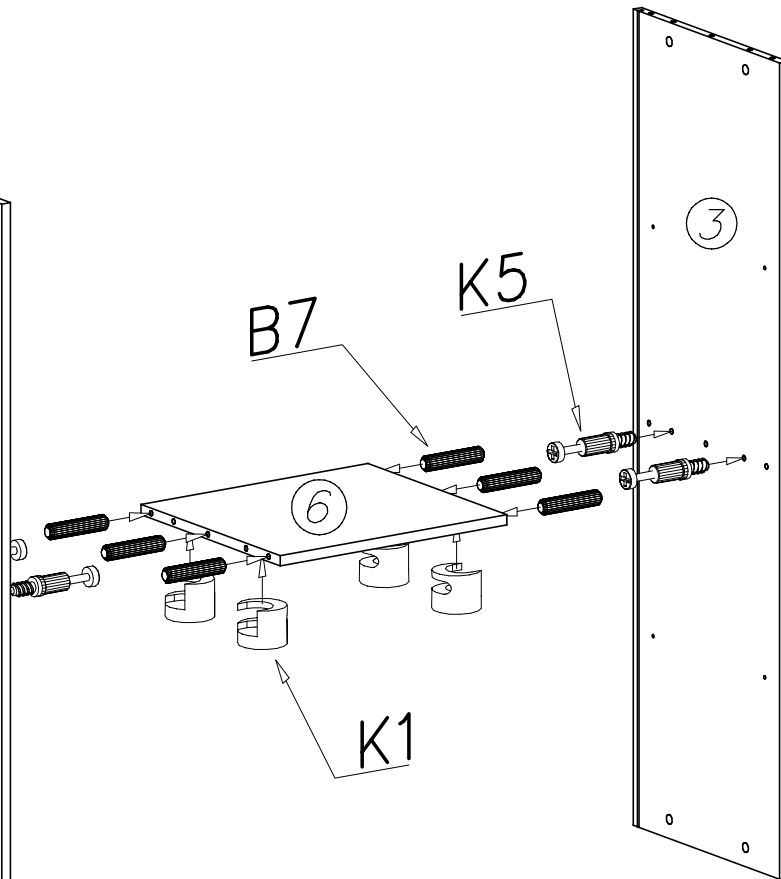
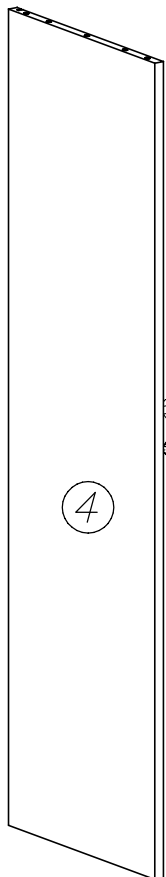

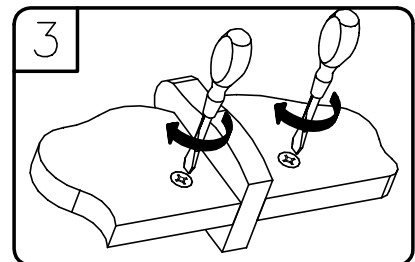
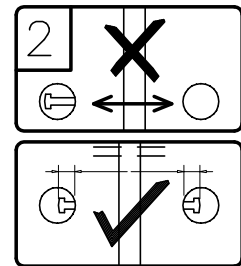
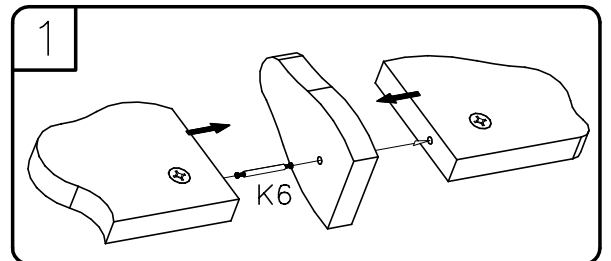
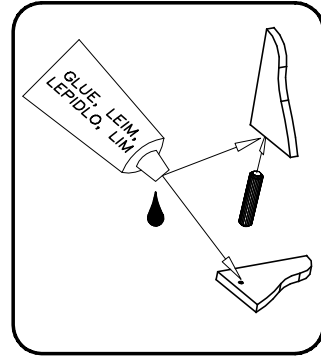
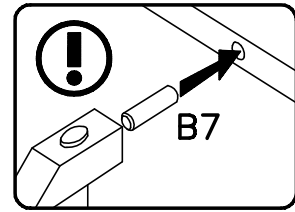
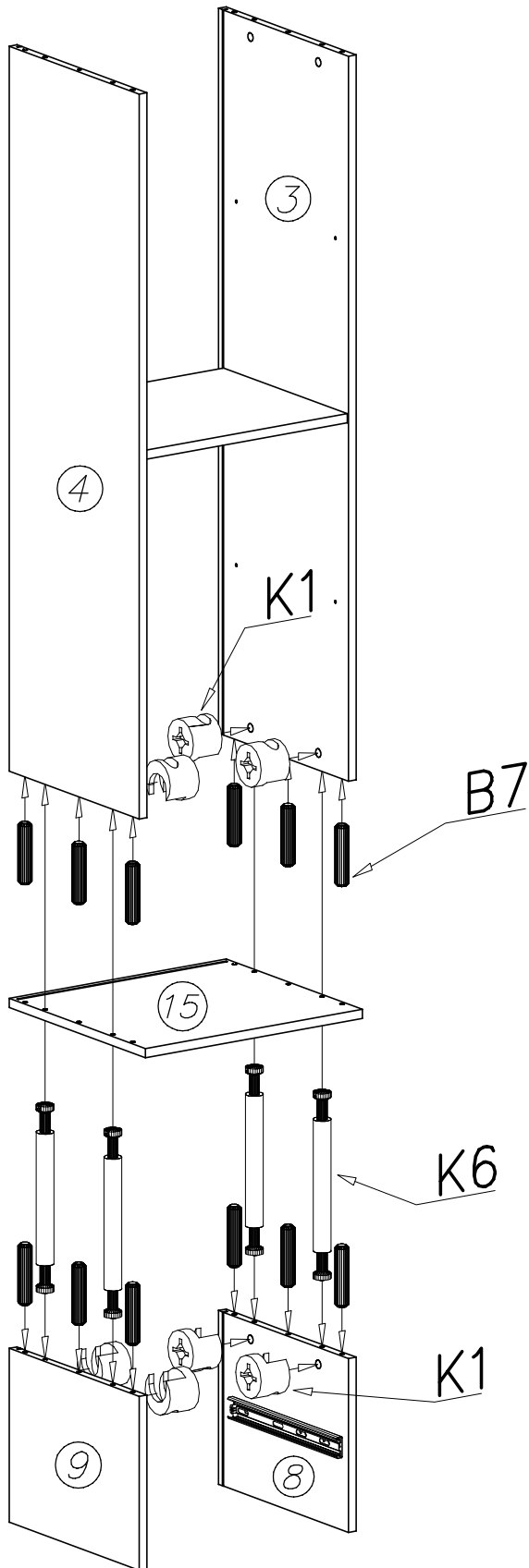

IV

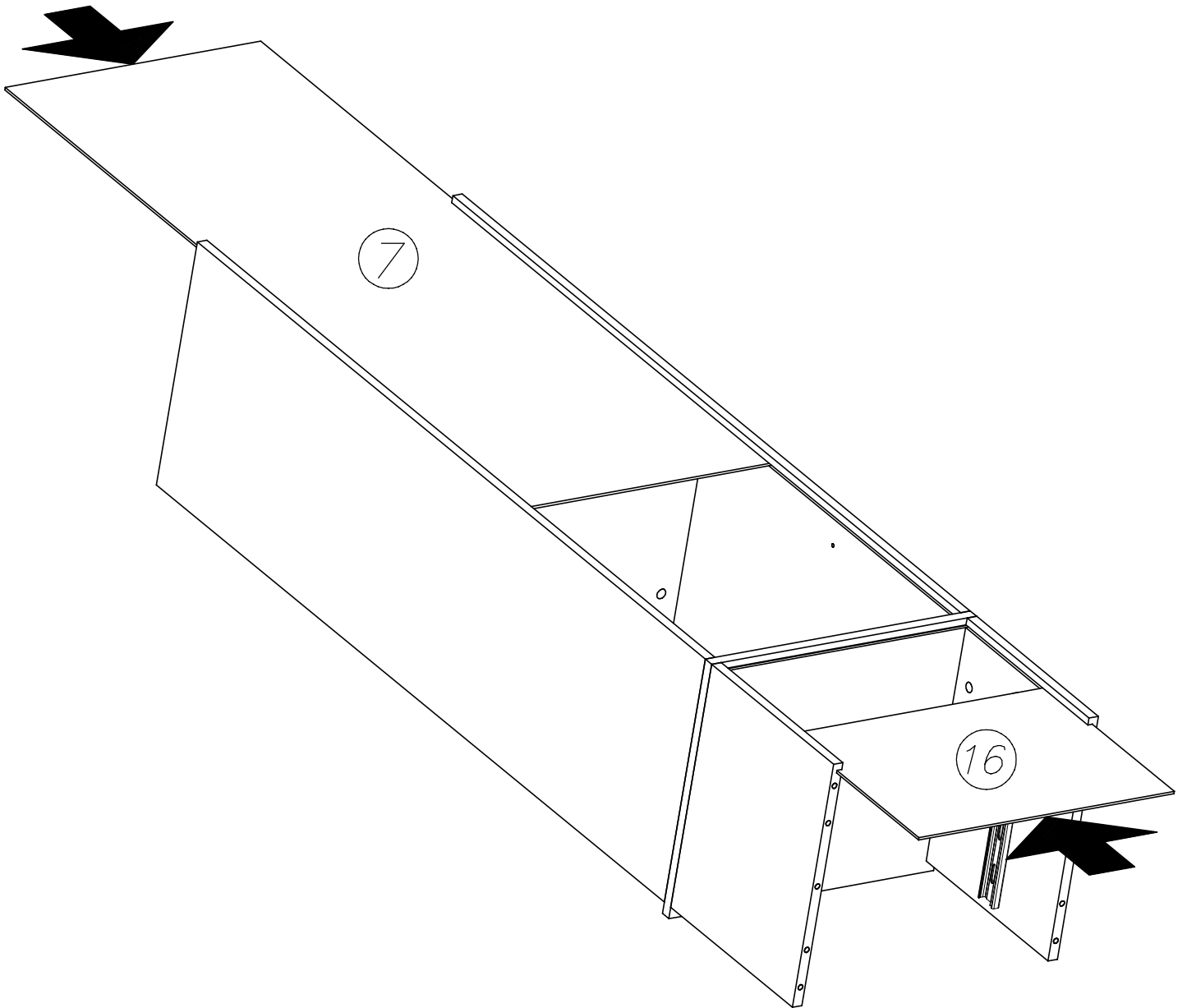

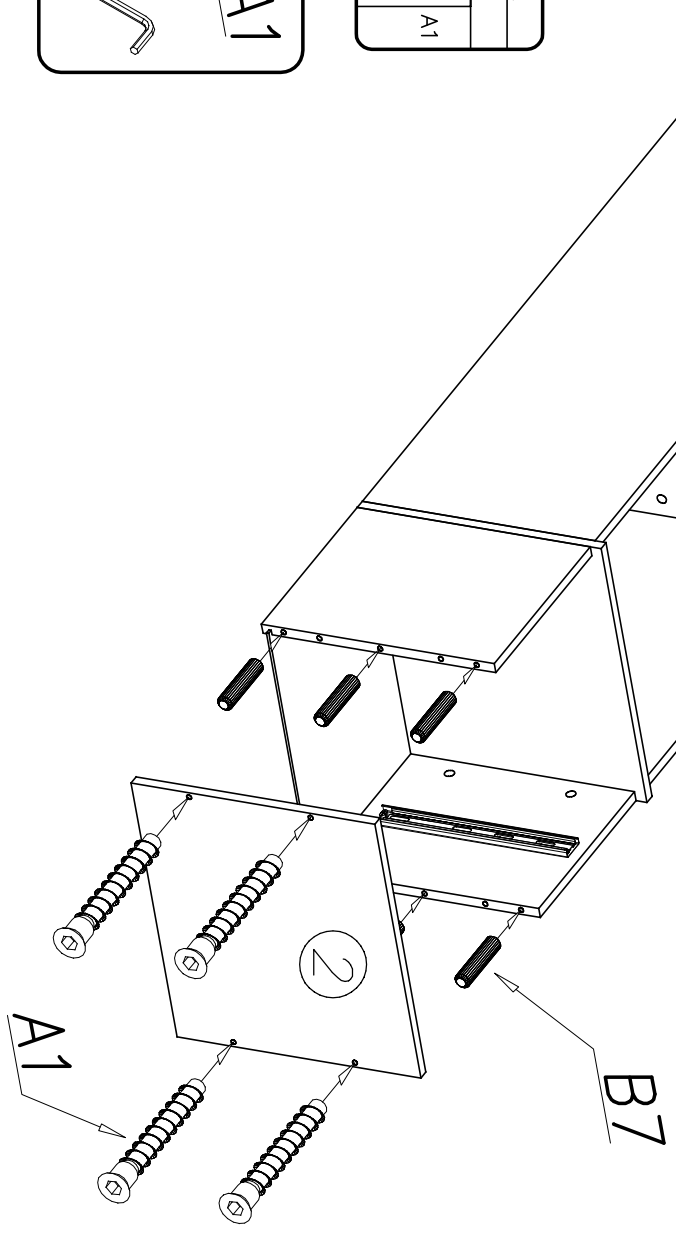
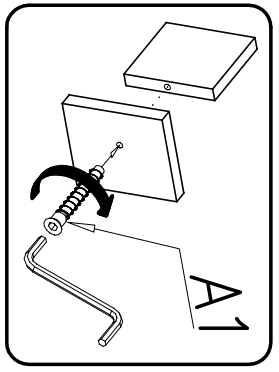
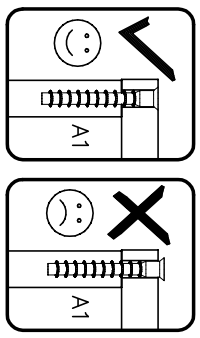
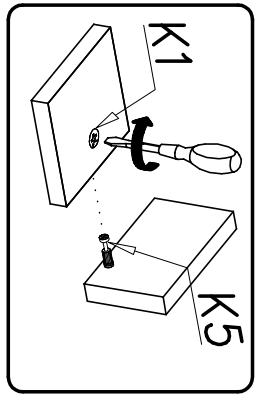
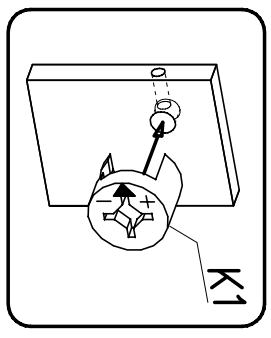
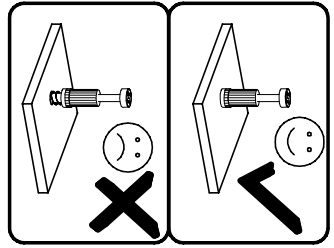
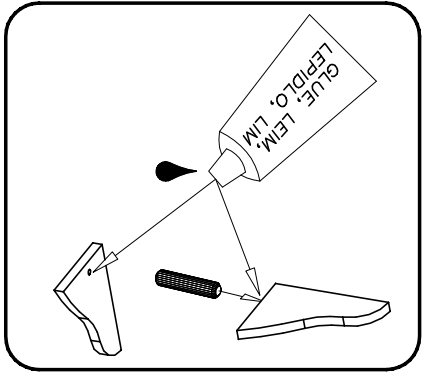
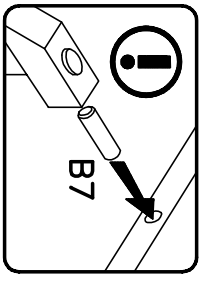
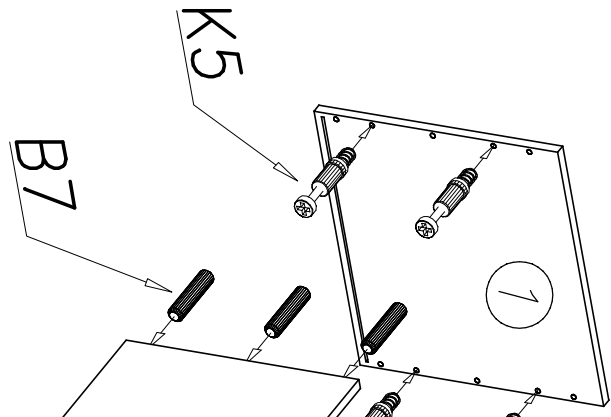

VI

A=B

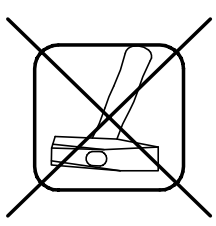
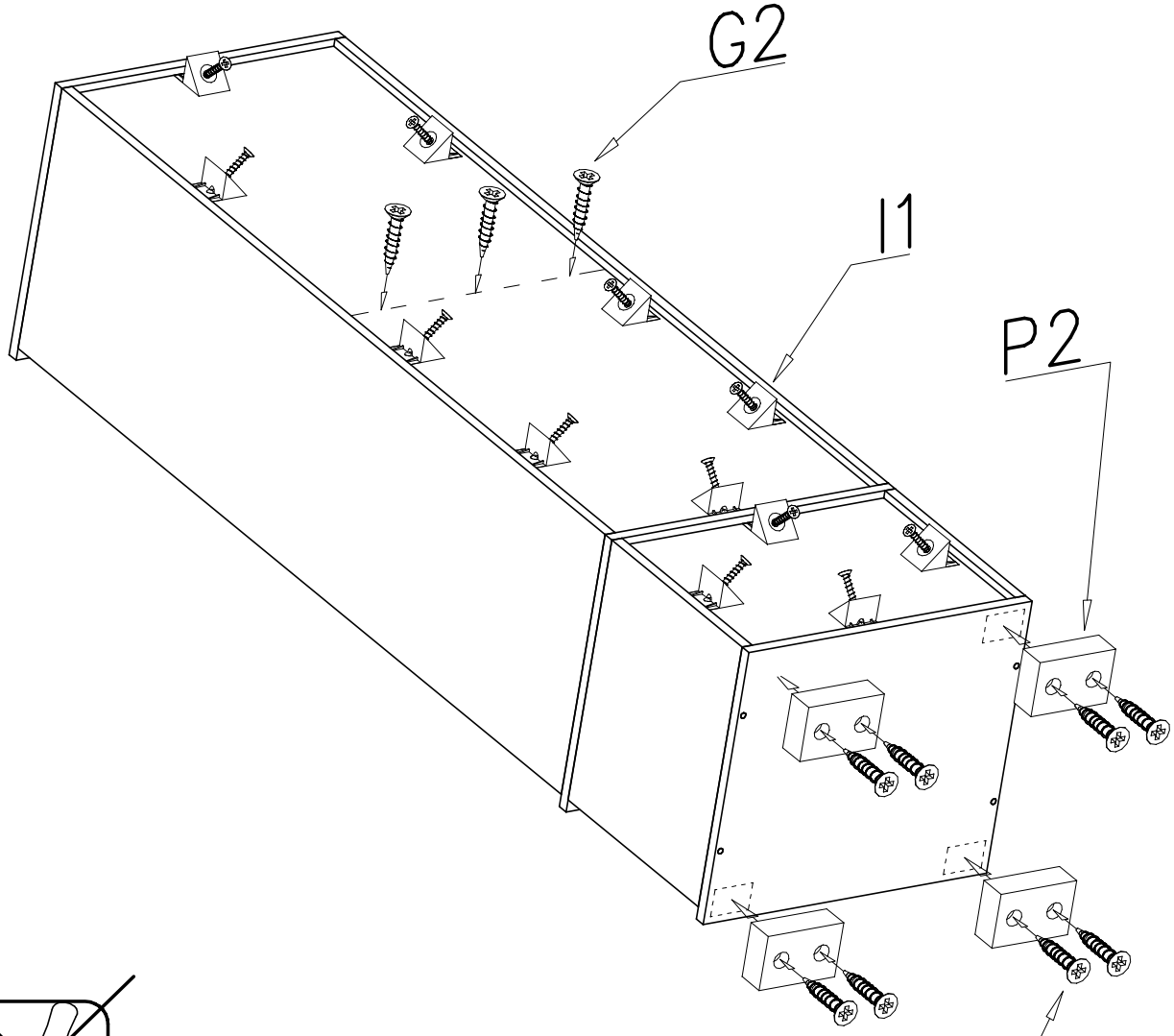
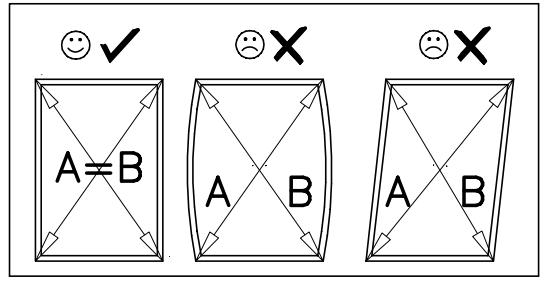
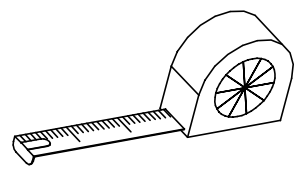

G12

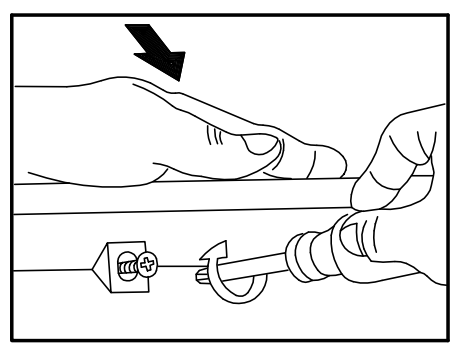
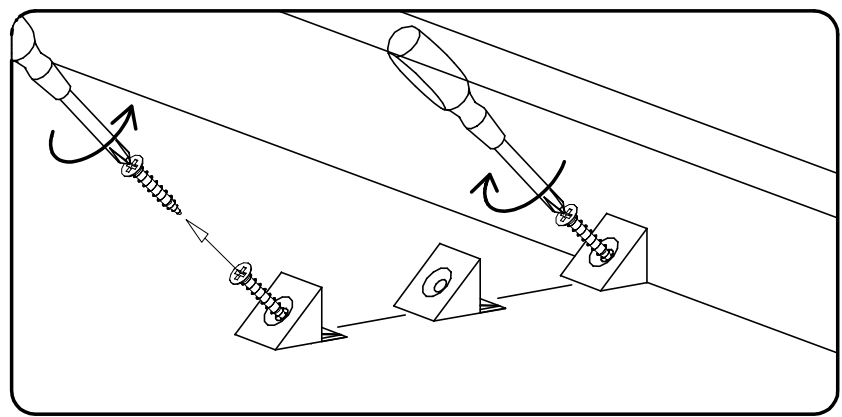

VII

