

MAURO

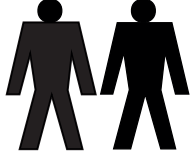

30min



PZ2

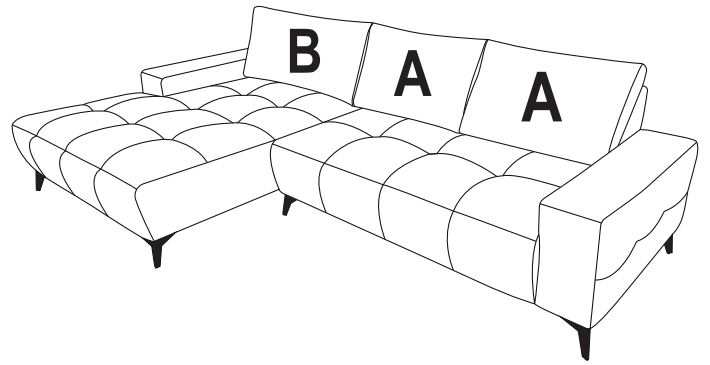
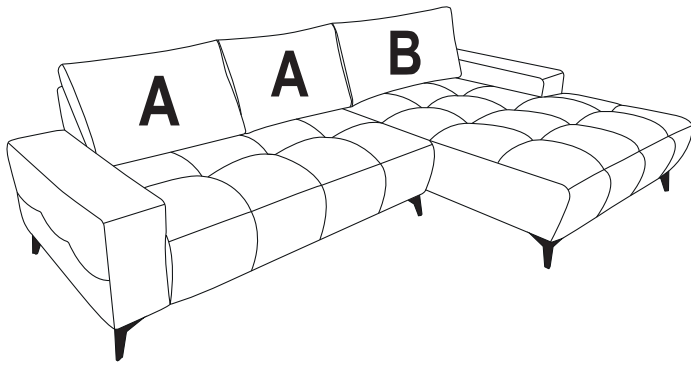

I

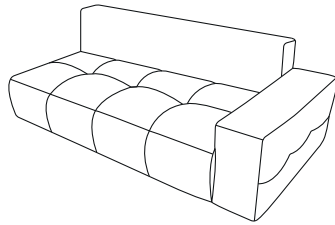
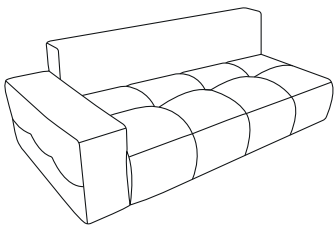

II

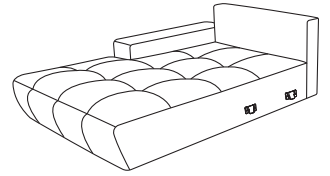
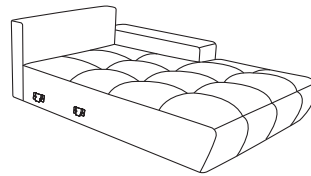

Ax2

Bx1

Cx6

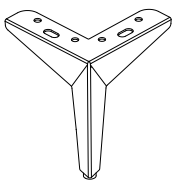

H=135 mm

Dx5

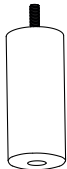

H=130 mm

Ex1

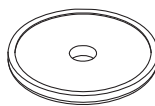

H=5 mm / Ø55 mm

Fx23

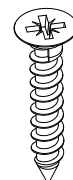

5x25



Gx1

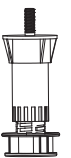

H=90-140 mm

1

Cx3

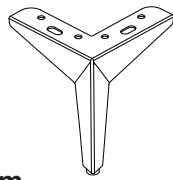

H=135 mm

Dx4



H=130 mm

Fx11

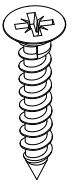

5x25



PZ2

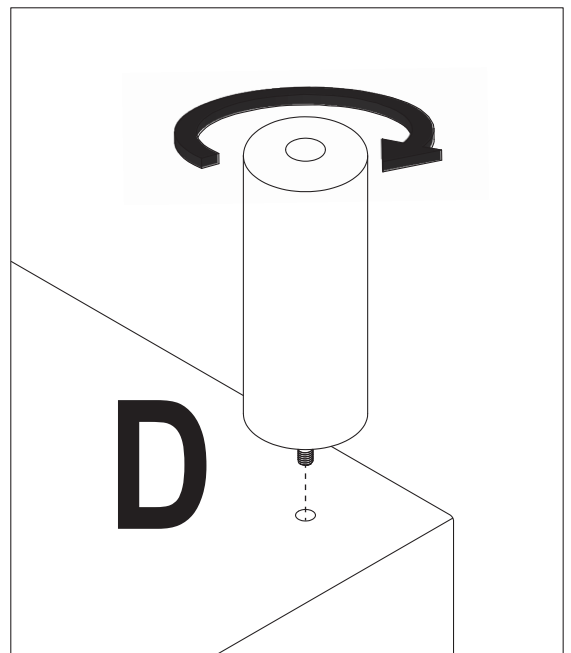
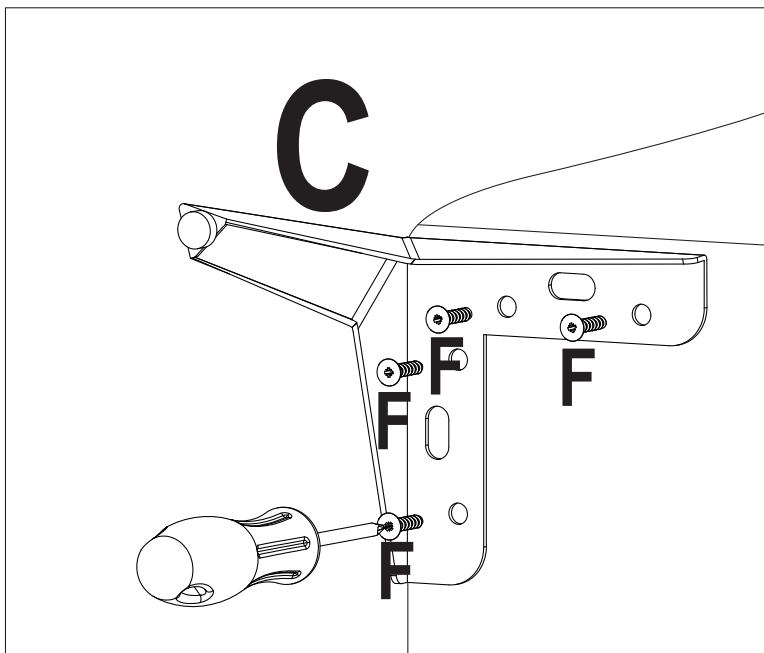
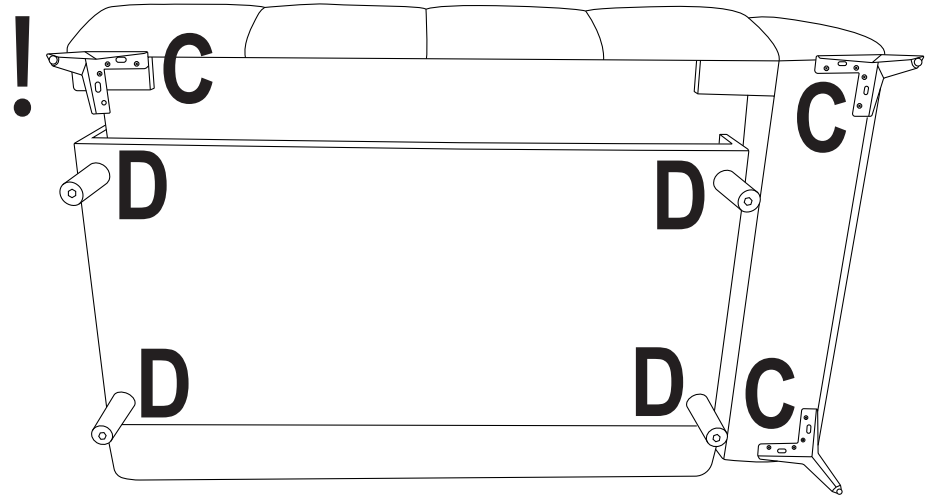
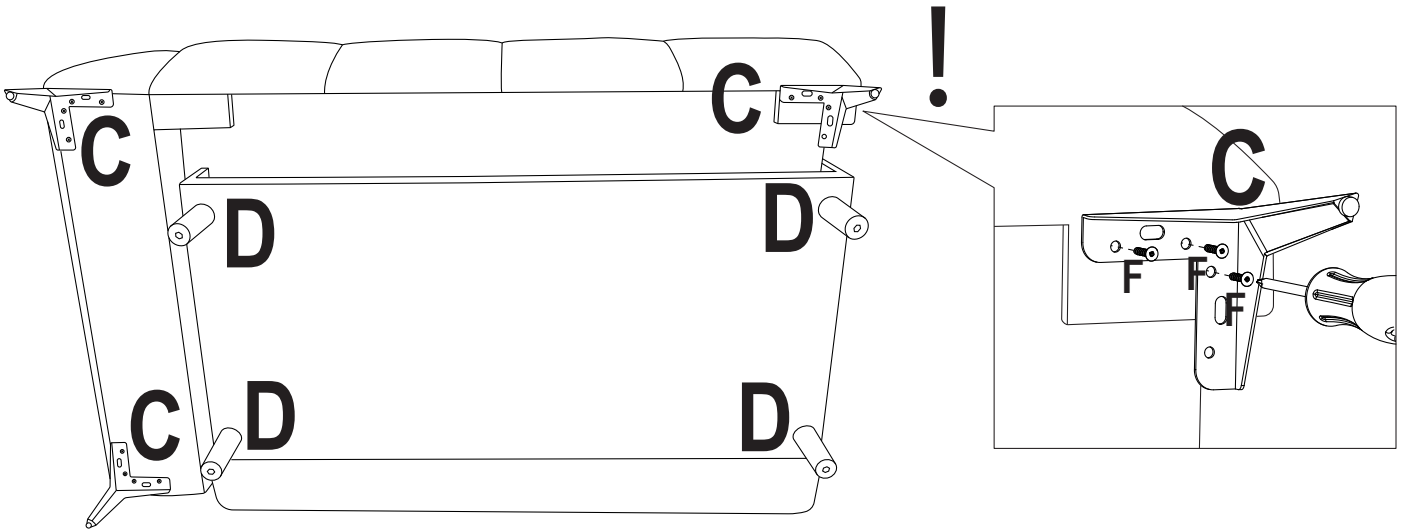

2

Cx3

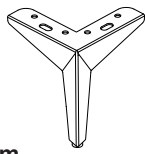

H=135 mm

Dx1



H=130 mm

Ex1



H=5 mm / Ø55 mm

Fx12

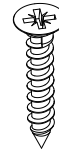

5x25



Gx1

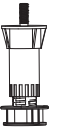

H=90-140 mm

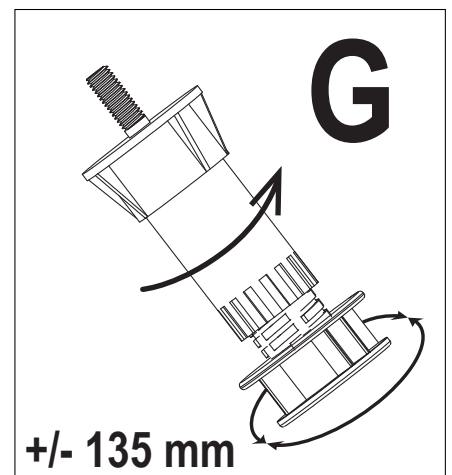
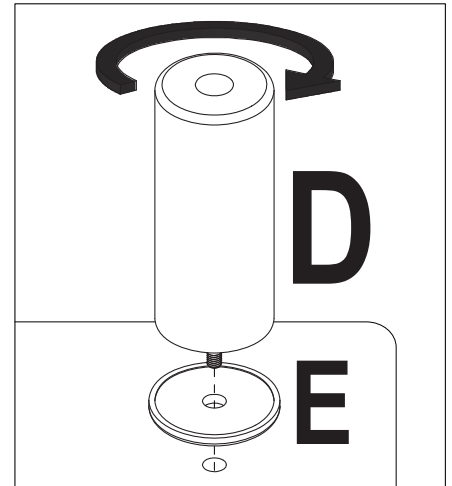
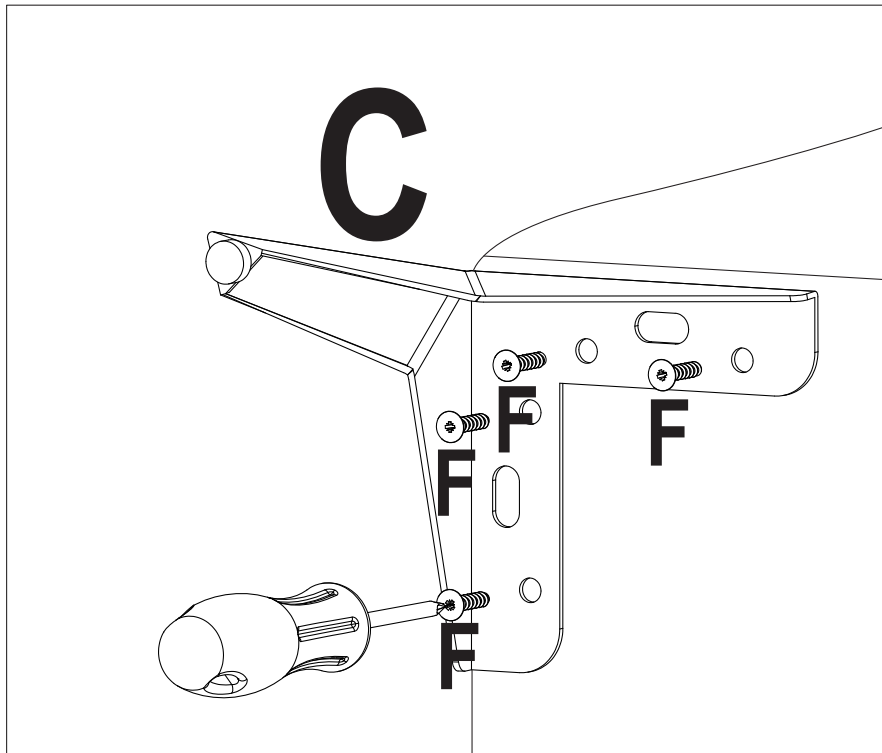
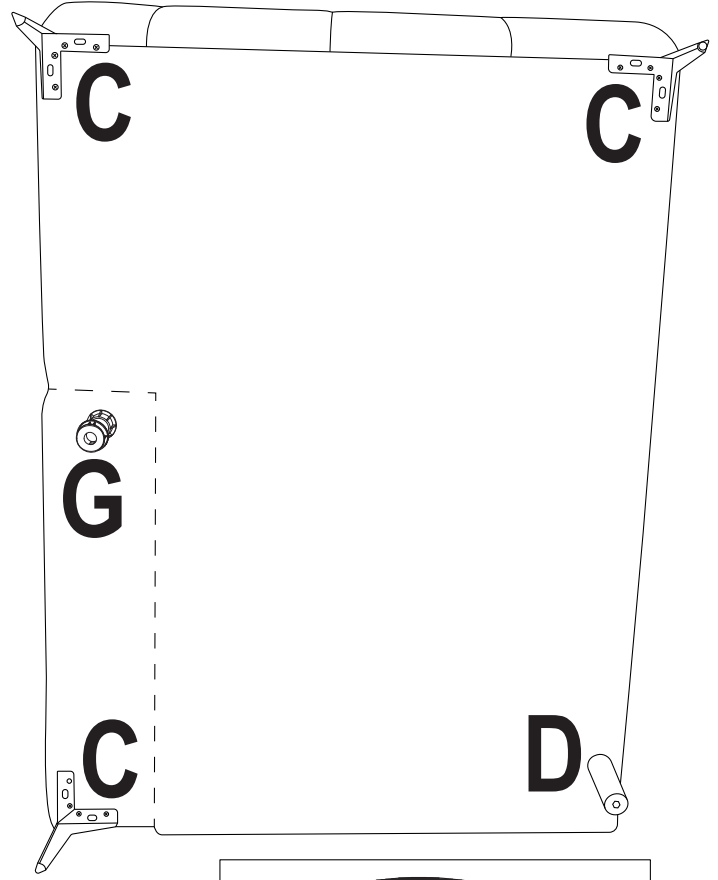
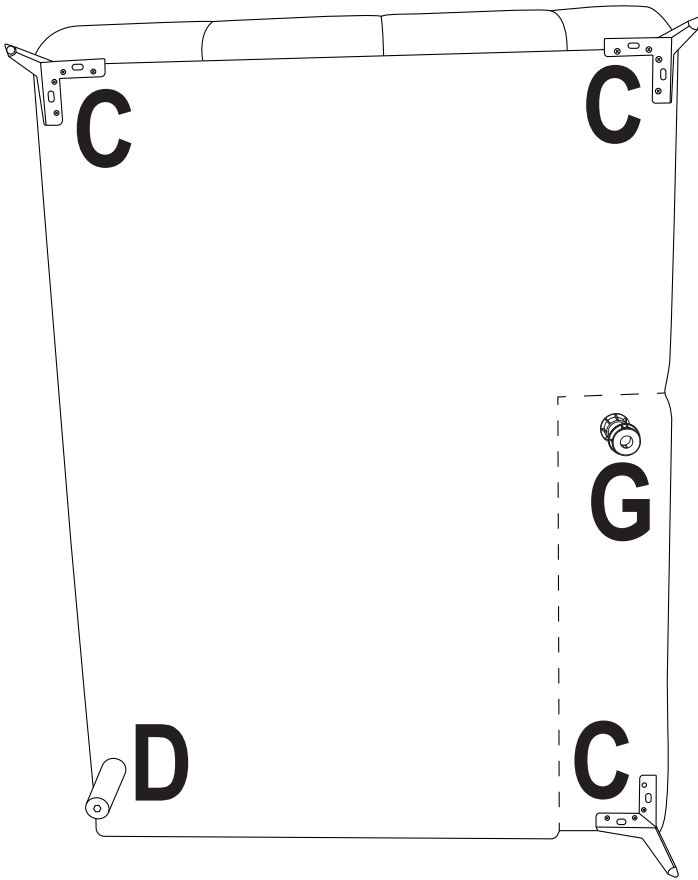

3

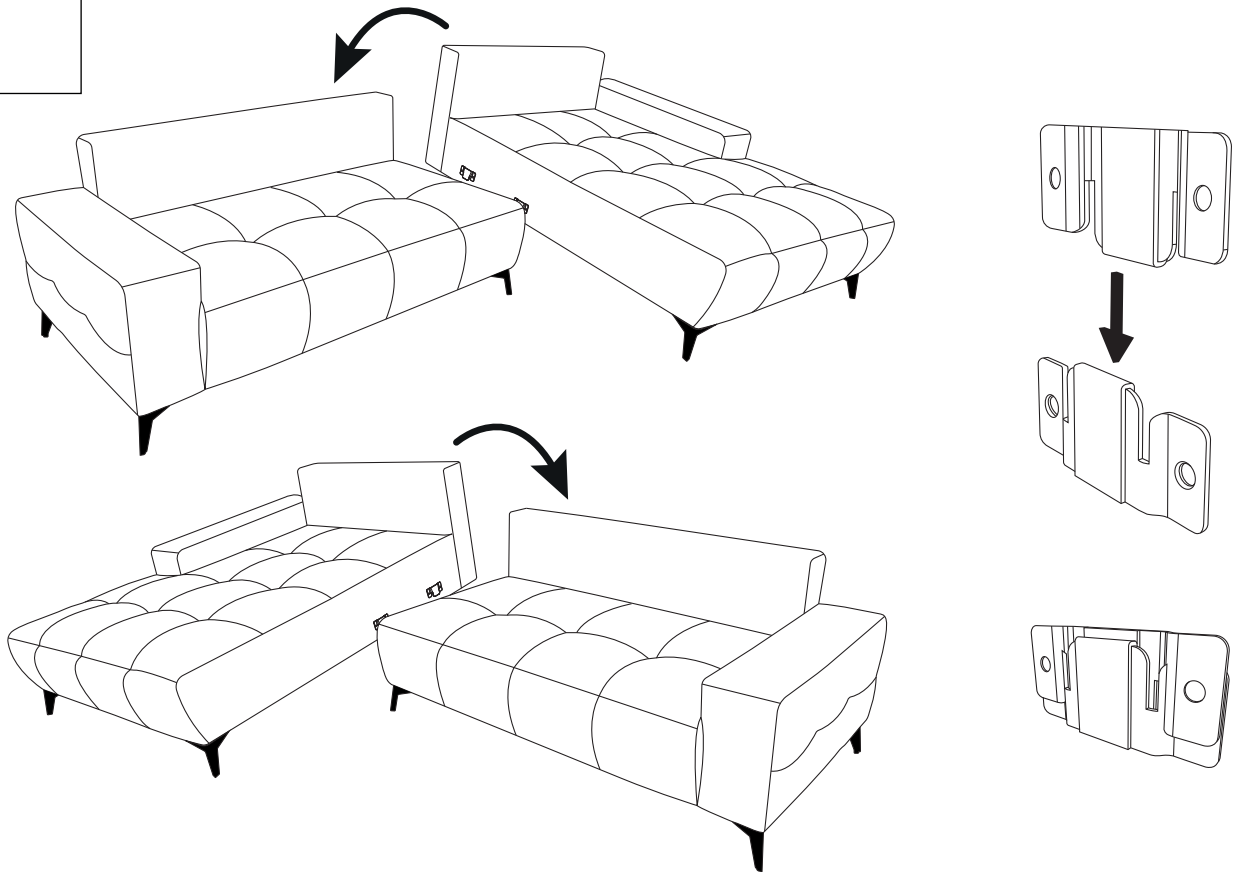

4

