

# Instalation manual

NORTON: WIE\_66\_HW

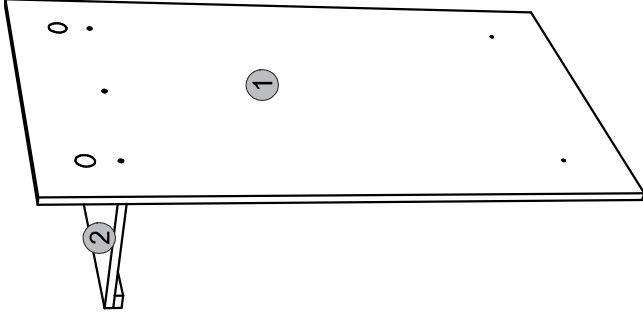

Element symbol	Dimensions	Code	Package
1	1150 660 16	1 N-048	1/1
2	560 284 16/32	1 N-047	2/2

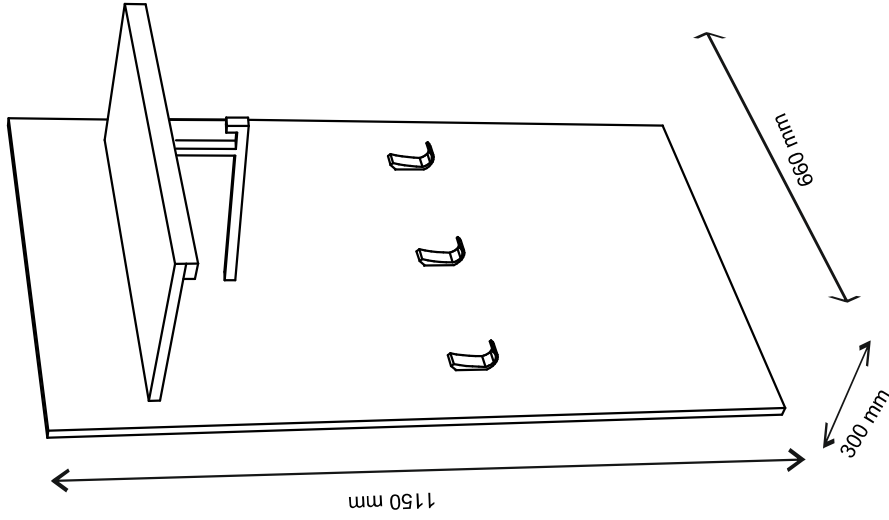
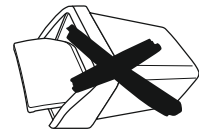
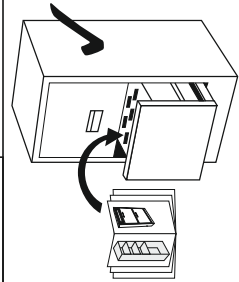
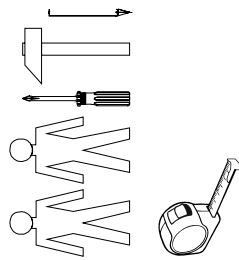
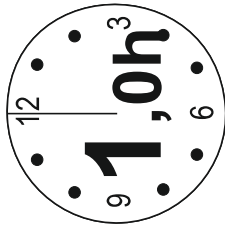
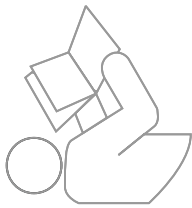
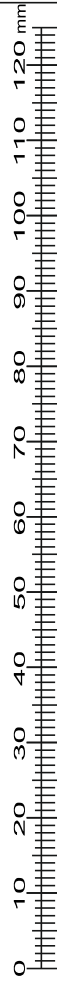
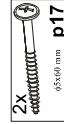
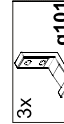

1

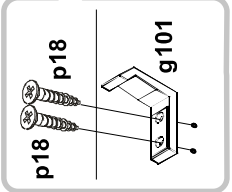
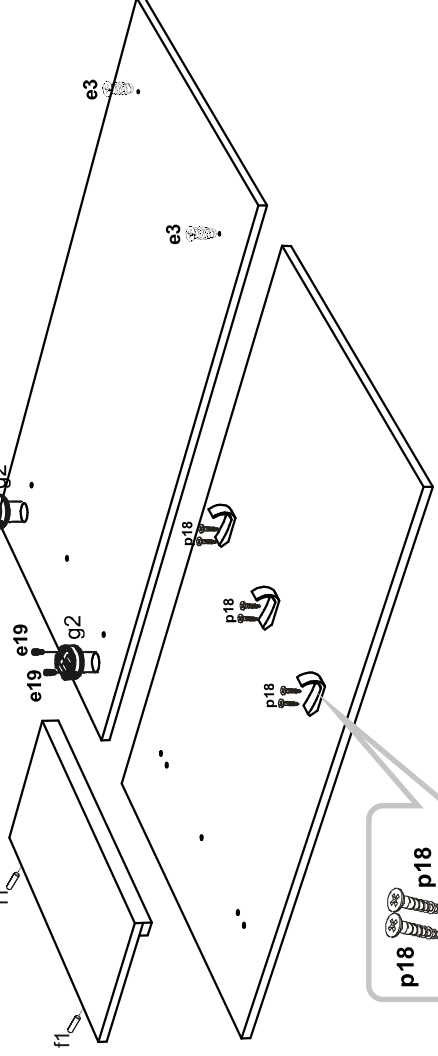
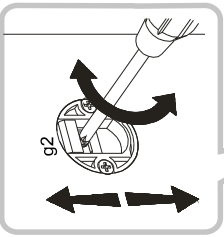
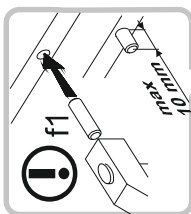

2

