

# Instructions for assembling furniture

## Instrukcja montażu mebli

Collection Kolecja mebli

### «DIESEL»

#### **Biurko A desk**

AH-029.02.00.00

#### **Biurko 120 A desk 120**

AH-029.22.00.00

#### **Biurko 1S A desk 1S**

AH-029.62.00.00

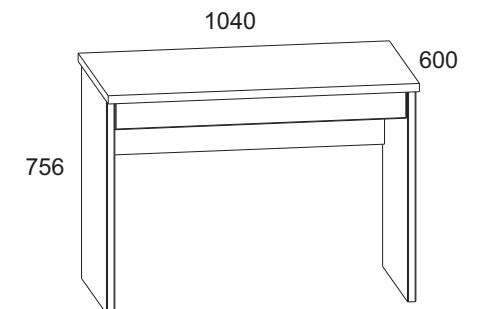
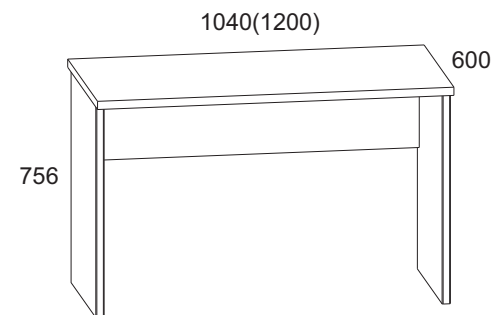

---

Production date  
Data produkcji

---

Stamp of Quality Department  
Pieczęć Działu Jakości

### Przy eksploatacji mebli zabrania się:

- ustawiać meble w pobliżu grzewczych przyrządów i obok wilgotnych ścian, a także w pomieszczeniach ze względną wilgotnością więcej niż 70%;
- temperatura nagrzewania elementów mebli nie może przekraczać +40°C;
- w trakcie montażu i eksploatacji mebli stawać nogami na poziome panele i witryny;
- stosować chemiczne środki czyszczące do sprzątania mebli;

### Gwarancje producenta

1. Gwarancyjny termin eksploatacji wyrobu - 24 miesiące z dnia sprzedaży. W okresie gwarancyjnego terminu producent gwarantuje naprawę wyrobów lub ich zamianę, jeżeli reguły eksploatacji nie zostały naruszone przez nabywcę.
2. Roszczenia są przekazywane przez nabywcę bezpośrednio do handlującej organizacji, w której były nabyte meble, tylko przy okazaniu danej "Instrukcji montażu" wraz z dokumentem zakupu.
3. Wyróby **Biurko, Biurko 120, Biurko 1S**, wchodzący w zestaw mebli **"DIESEL"**, odpowiada wymaganiom Norm Państwowych 16371-93, TPTC 025/2012
4. Trwałość użytkowa mebli - 10 lat.
5. Firma-producent pozostawia za sobą prawo do wprowadzania zmian w konstrukcje wyrobów, nie pogarszając ich konstruktywne i eksploatacyjne charakterystyki.
6. Do montażu wyrobów zaleca się skorzystanie z pomocy wykwalifikowanych specjalistów.

**Ważne!** Proszę zachować instrukcję w razie ponownego montażu mebli lub reklamacji. Podczas składania reklamacji prosimy o korzystanie z oznaczeń z

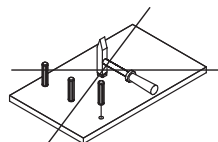
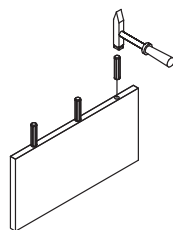
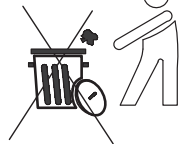

### Instruction manual.

It's advised to check the quality and completeness of the product in the store when buying unpacked. Assembling of the product should be done the way it's described in this manual. While the product is in service loose screw connections should be periodically tightened. If it's necessary to move items around the apartment before moving you should release the product completely from the load (the mattress). To prevent damage to existing supports the product should be lifted before moving. Dusting the product should be done with a slightly damp soft cloth. To prevent warping of parts and discoloration of products do not install furniture in direct sunlight.

### While the product is in service it's **PROHIBITED TO:**

- Install furniture near heating devices, close to the raw walls and in rooms with a relative humidity of more than 70%;
- heat elements of furniture to the temperature higher 40 C;
- step on the horizontal shields and windows during assembly and use of the products set;
- use chemical cleaners for cleaning furniture;

### Manufacturer's warranty.



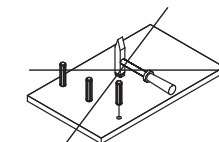
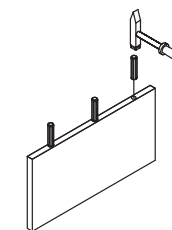
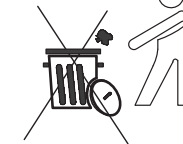
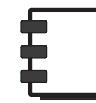





1. The warranty period of use of the product - 24 months from the date of sale. During the warranty period the manufacturer guarantees repair or replacement of products, if the user has not violated operating rules.
  2. Claims should be made by the consumer directly to the trading organization, in which furniture was purchased, presenting the "Instruction manual" and a copy of the sales receipt.
  3. The products, **A desk, A desk 120, A desk 1S**, which are a part of a set of **«DIESEL»**, meets the requirements of GOST 16371-93, TR TS 025/2012.
  4. The lifetime of furniture - 10 years.
  5. The manufacturer reserves the right to make changes in product design, without compromising its design and application requirements.
  6. To assemble the products it's recommended to attract qualified personnel.
- It is important!** Keep the instruction in case of reassembly of furniture or complaint. When making a claim use the notation from the instruction.

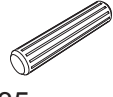

№ эл-та	Длина мм.	Ширина мм.	Толщина мм.	Кол-во шт.	№ пачки
1	1040(1200*,1040**)	600	28	1	1/2(1/3**)
2	978(1138*,978**)	300	16	1	1/2(1/3**)
3	724	500	28	1	2/2(2/3**)
4	724	500	28	1	2/2(2/3**)
148**	303	80	16	1	3/3
161**	974	100	16	1	3/3
180**	320	80	16	1	3/3
181**	320	80	16	1	3/3
190**	920	80	16	1	3/3
317**	950	325	2,5	1	3/3

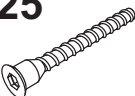
\*- Стол письменный 120  
Biuurko 120  
A desk 120

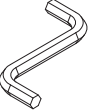
\*\*- Стол 1S  
Biuurko 1S  
A desk 1S

<b>A1</b>  5	<b>A2</b>  5	<b>C1</b>  8x35 10
<b>S8</b>  6* 6**	<b>S5</b>  5	<b>R25</b>  7x70 4
<b>N1</b>  4	<b>I</b>  1	<b>S9</b>  4

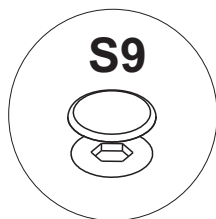
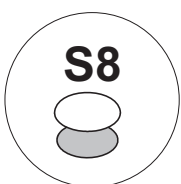
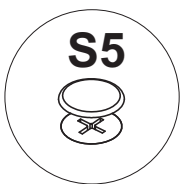

«DIESEL»

Biuurko 1S  
A desk 1S

Biuurko  
A desk

Biuurko 120  
A desk 120

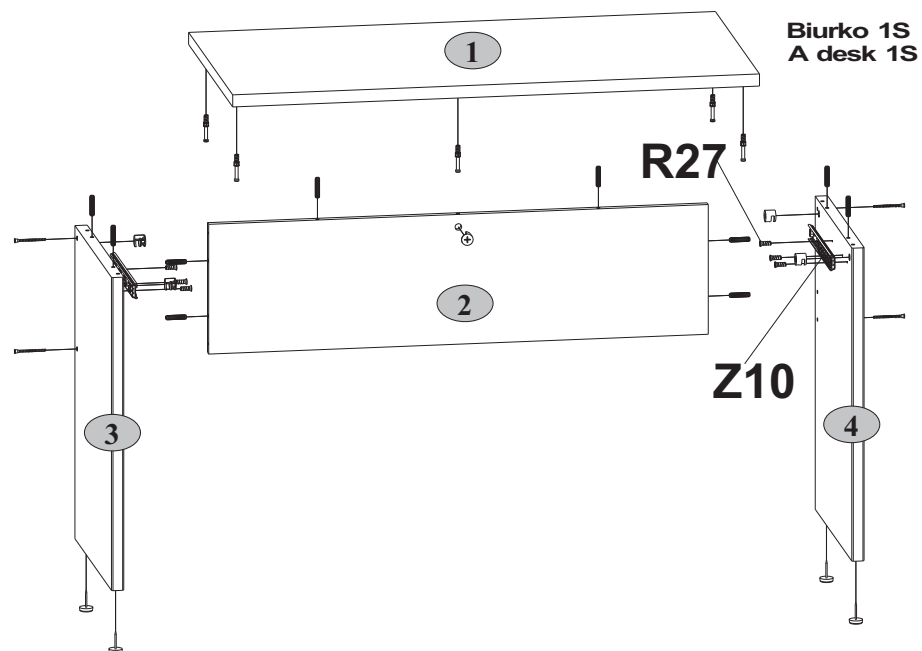
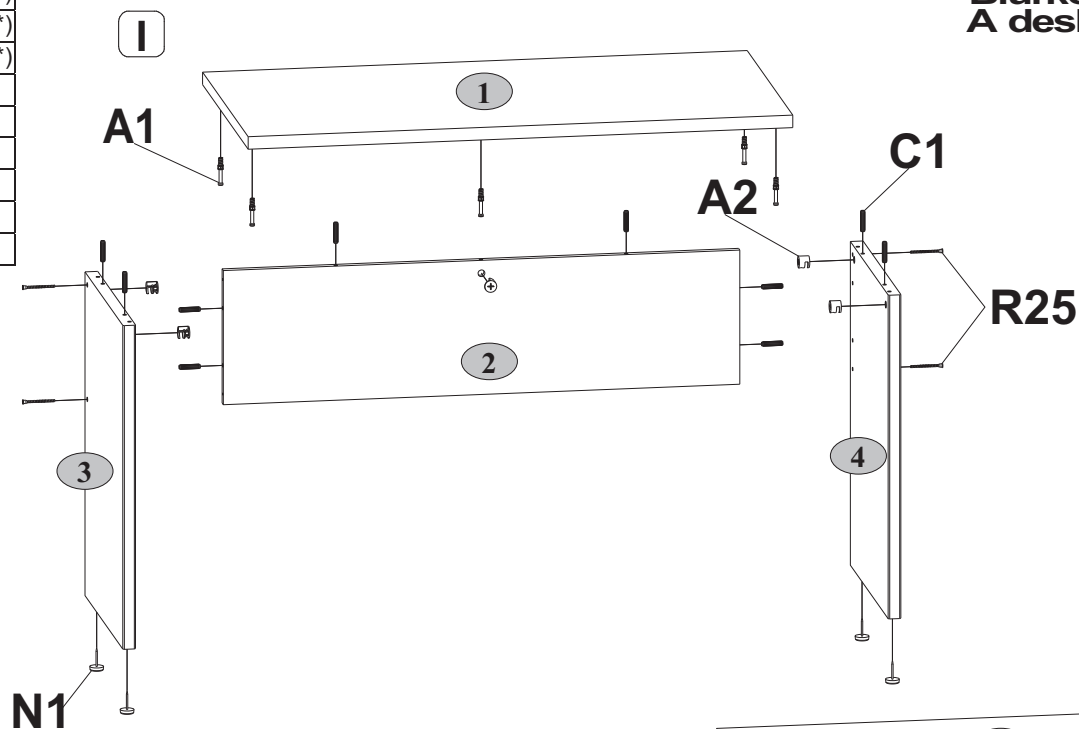

«DIESEL»





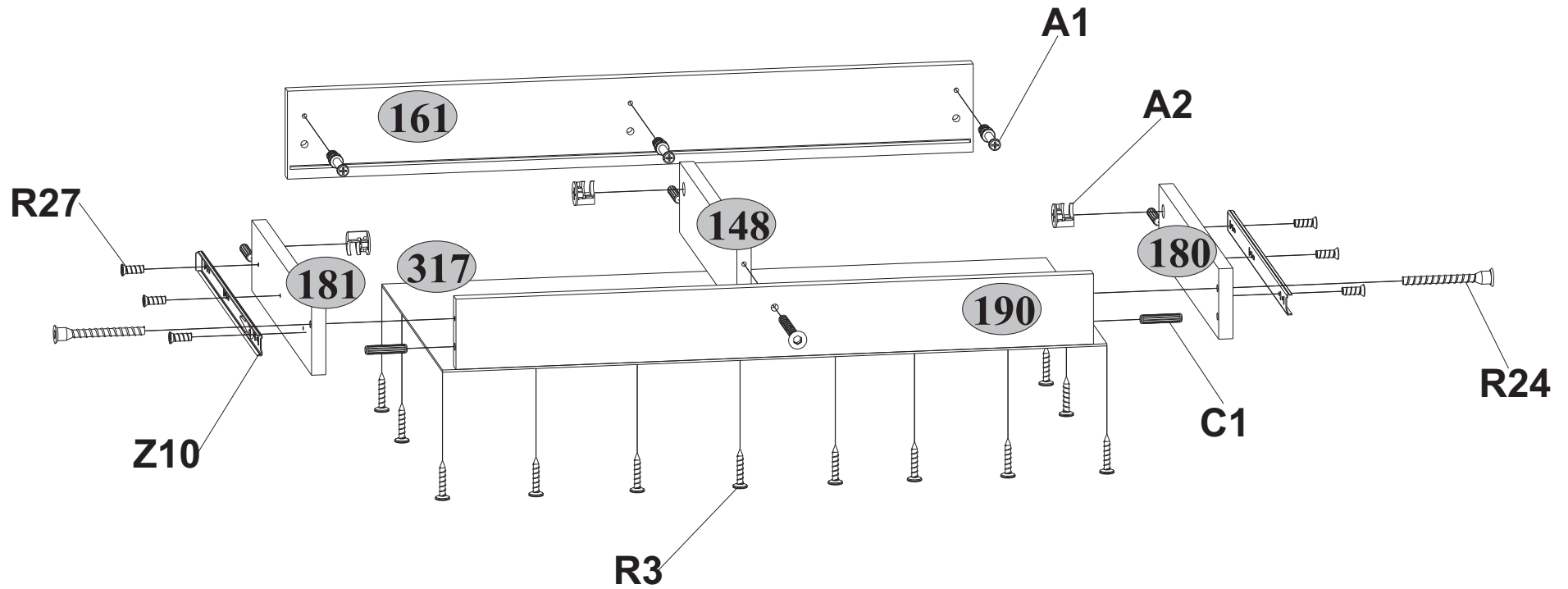

Biurko 1S  
A desk 1S

Biurko  
A desk

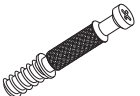
Biurko 120  
A desk 120

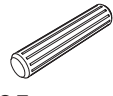
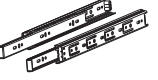

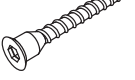
Biurko 1S  
A desk 1S

<b>A1</b>  3	<b>A2</b>  3	<b>C1</b>  8x35 6
<b>Z10</b>  300 1	<b>R3</b>  3x20 12	<b>R24</b>  7x50 3
<b>R27</b>  5,0x13 10		

