

# Instrukcja montażu mebli

«DIESEL»

Komoda 3S

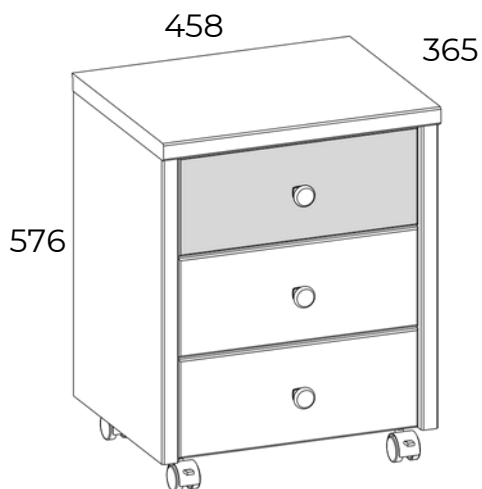

---

Production date  
Data produkcji







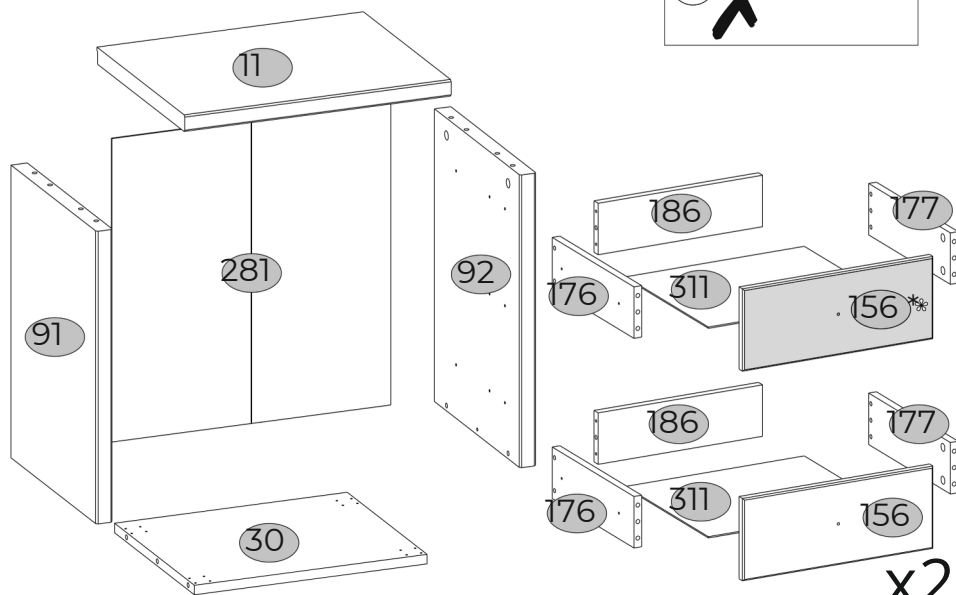
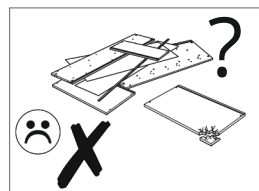

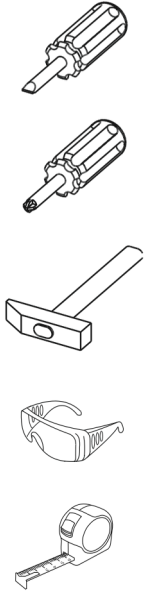



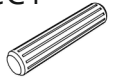

---

Stamp of Quality Department  
Pieczęć Działu Jakości

№	L, mm	B, mm	H, mm	Q	№ pack
11	458	365	28	1	1/1
30	400	332	16	1	1/1
91	492	355	28	1	1/1
92	492	355	28	1	1/1
156	396	160	16	2	1/1
156*	396	160	16	1	1/1
176	320	100	16	3	1/1
177	320	100	16	3	1/1
186	342	100	16	3	1/1
281	510	450	2,5	1	1/1
311	372	325	2,5	3	1/1

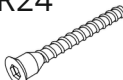

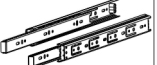

A1.0  5x28 18	A2  Ø15x13 18	CC1  8x35 420
G  1,5x26 12	H23  3	I  S4 1
M4  M4x22 3	N7  2	N8  2
R3  3x20 24	R24  7x50 12	R27  5,0x13 30
R102  3,5x16 16	S5  Ø18 12	Z10  300 3

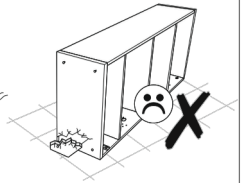
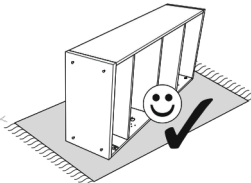
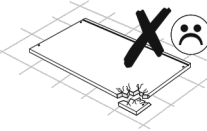
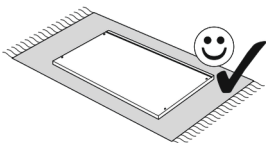
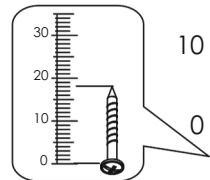
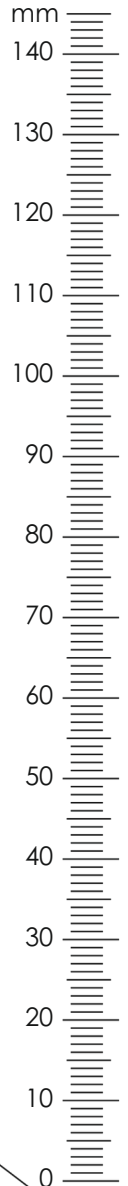

1

A1.0 5x28	A2 2 Ø15x13	CC1 4 8x35	R27 4 4,0x13	Z10 18 300
--------------	----------------	---------------	-----------------	---------------

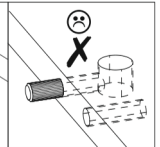
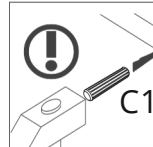
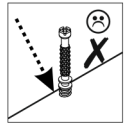
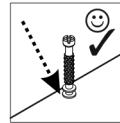
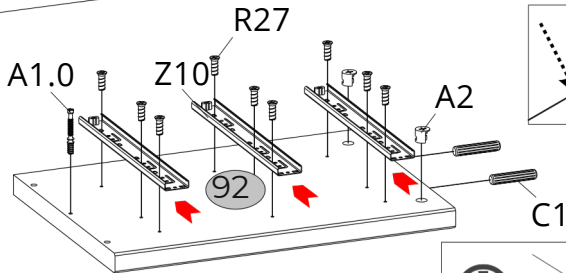
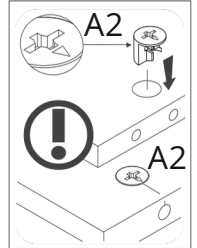
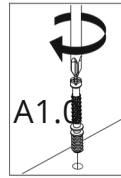
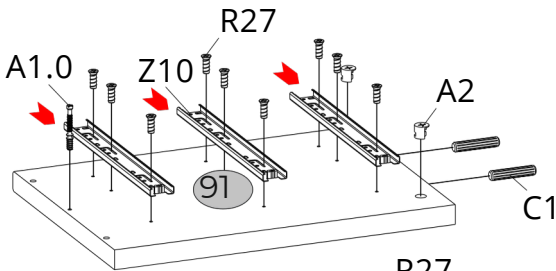
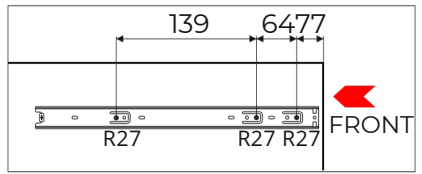
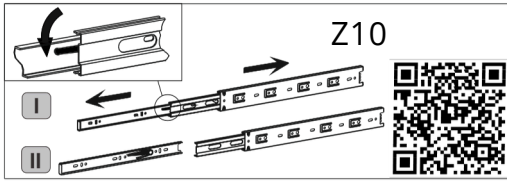

2

A1.0 5x28	4
--------------	---

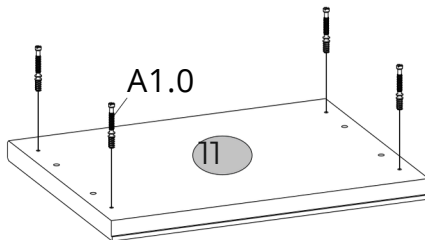

3

A2



Ø15x13

CC1

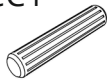

2 8x35

N7

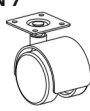

404 2

N8



2

R102



2 3,5x16 16

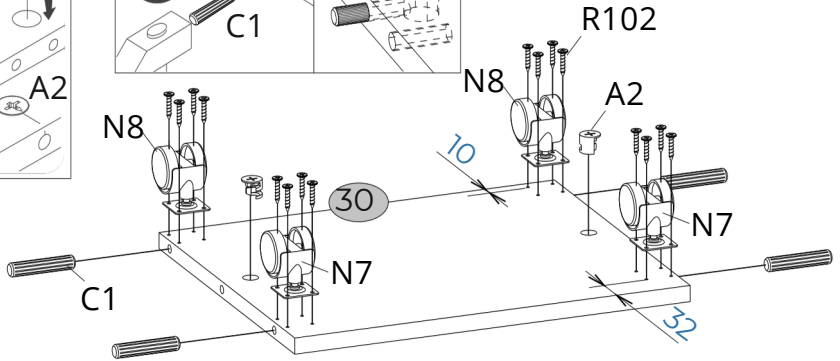
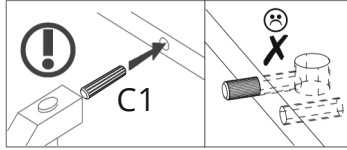
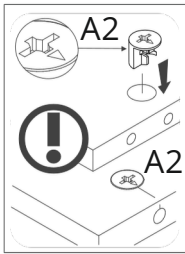

4

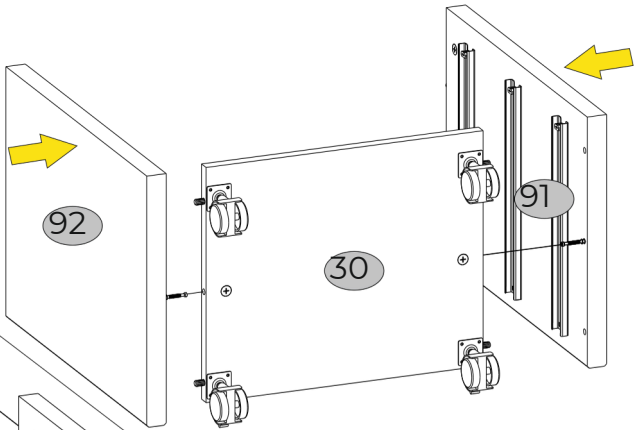

5

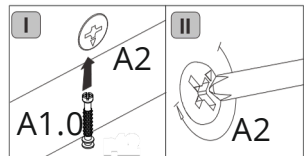
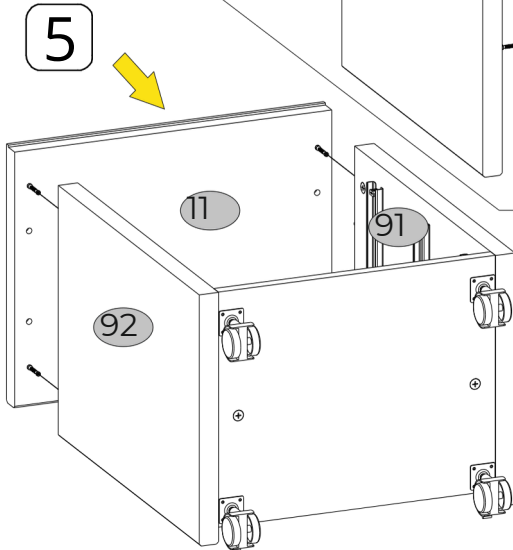

6

G  
1,5x26 12



I

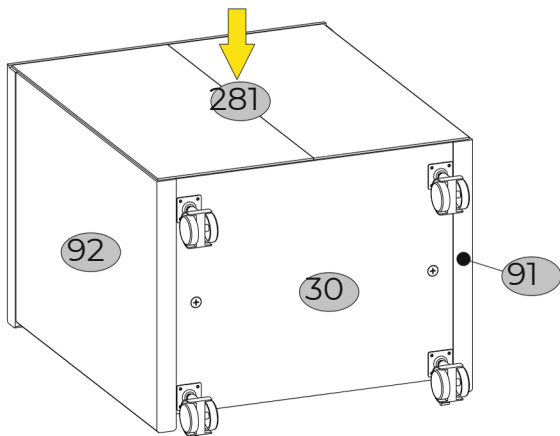

II

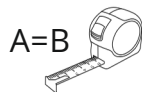
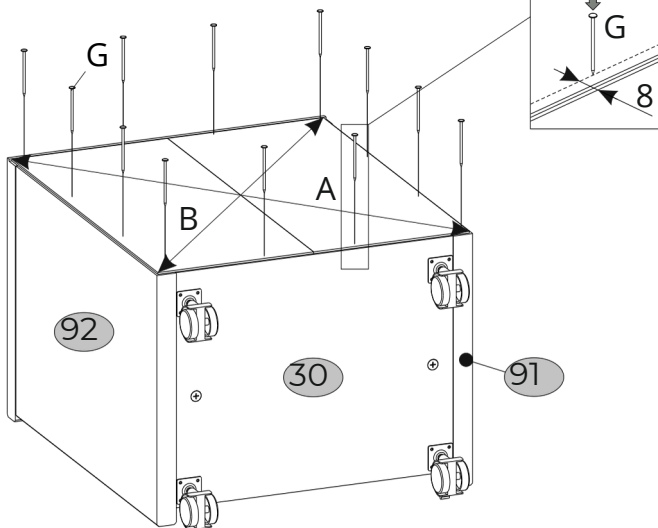

  
A=B  
90

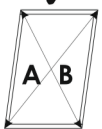

**7**  
x3

A1.0 5x28 12	A2 Ø15x13 12	CC1 8x35 4	H23 102 3
I S4 1	M4 M4x22 3	R24 7x50 12	R27 5,0x13 12
Z10 300 3			

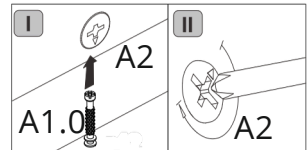
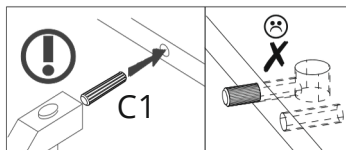
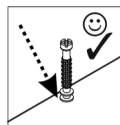
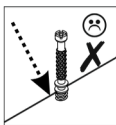
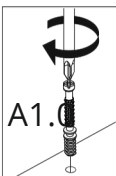
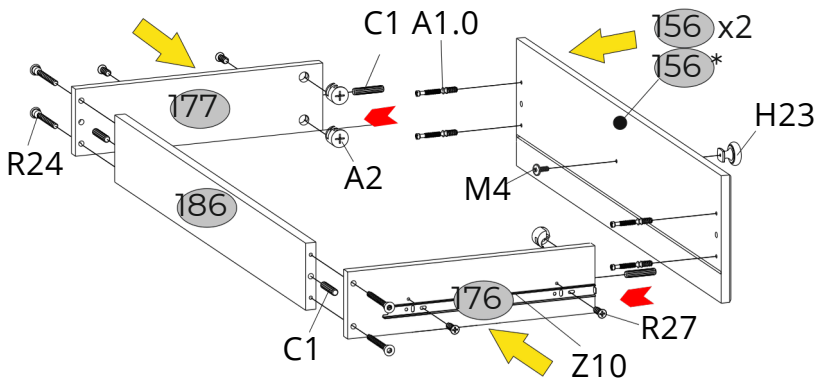
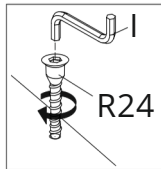
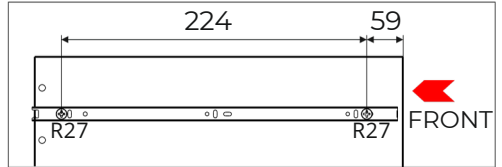
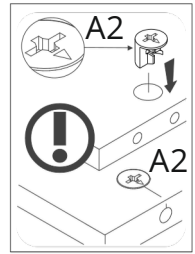

8

x3

R3



3x20

24

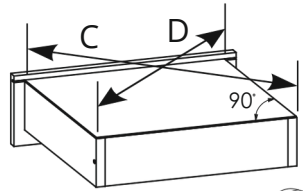

C=D

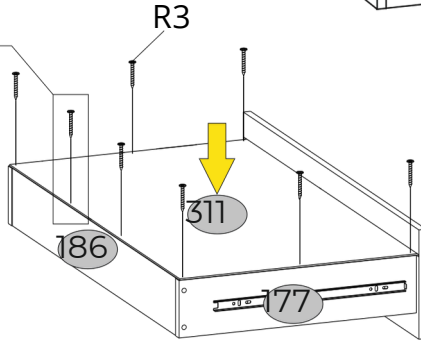
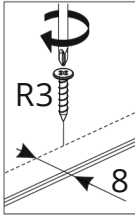
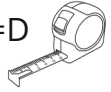

9

S5



Ø18

12

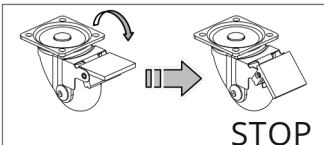
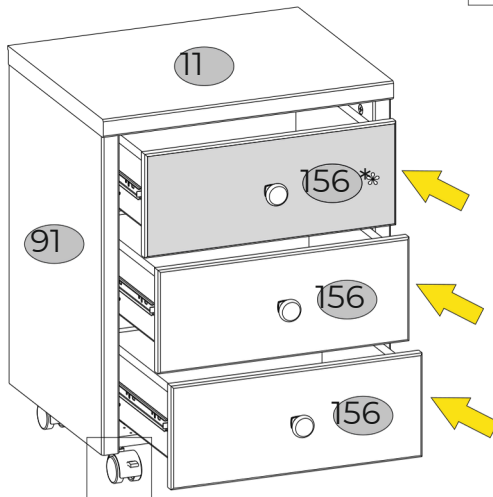
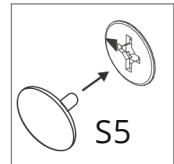

11 156 156 \*

max. 5 kg