

Instrukcja montażu mebli

«DIESEL»

Półka T

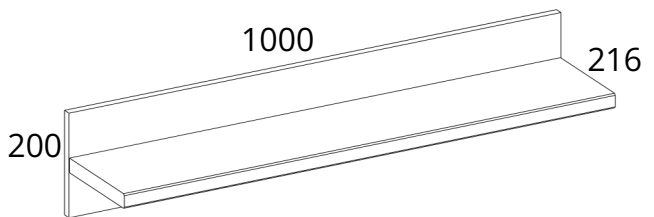

Półka T

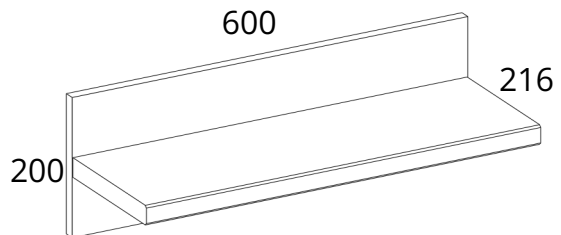

Production date
Data produkcji



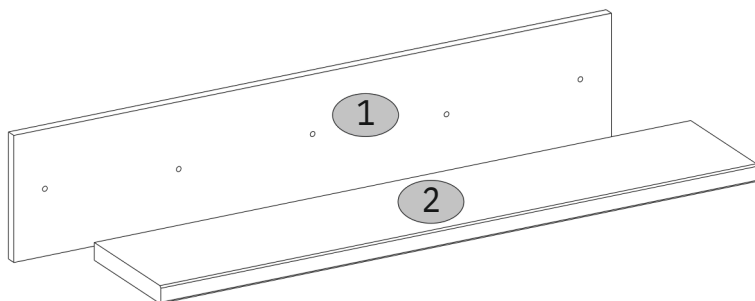

Stamp of Quality Department
Pieczęć Działu Jakości

No	L, mm	B, mm	H, mm	Q	No pack
1	1000(600*)	200	16	1	1/1
2	998(598*)	200	28	1	1/1

*- Szafka wisząca TL, Hinged shelf TL.



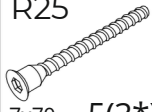

B3  Ø35 2	B5  10x50 2	I  S4 1	R25  7x70 5(3*)
R27  5,0x13 6			

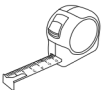
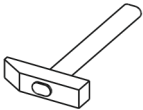
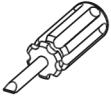

*- Szafka wisząca TL, Hinged shelf TL.

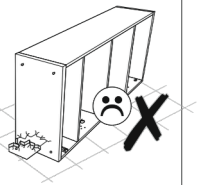
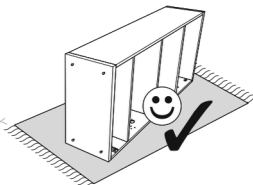
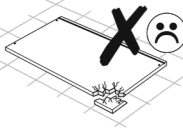
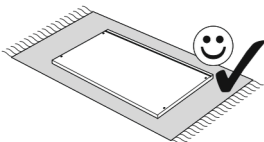
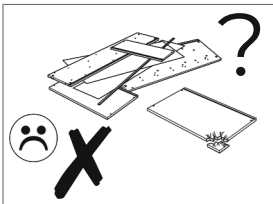
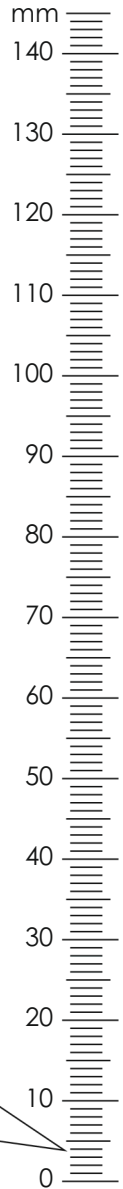

1

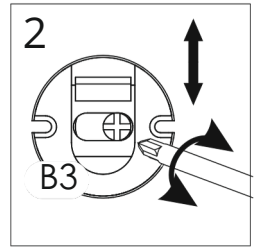
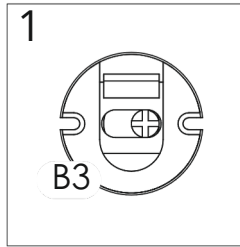
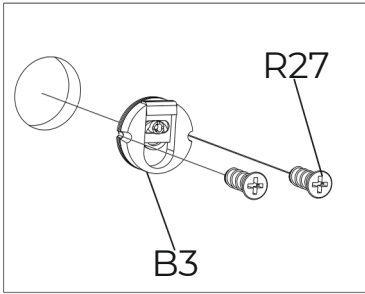
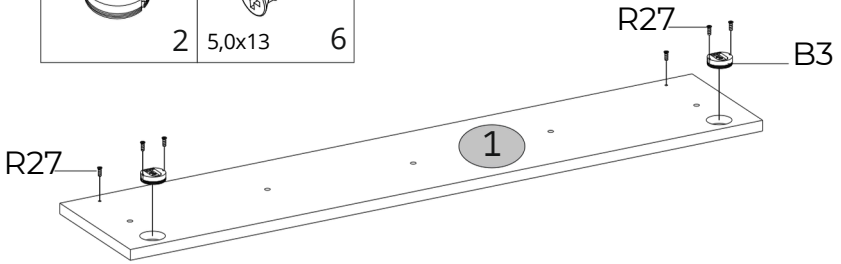
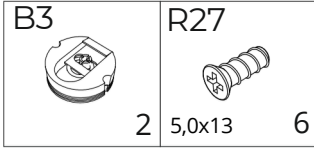

2

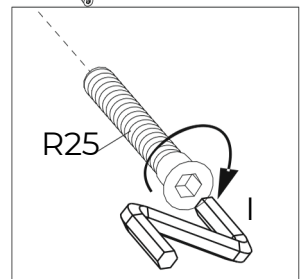
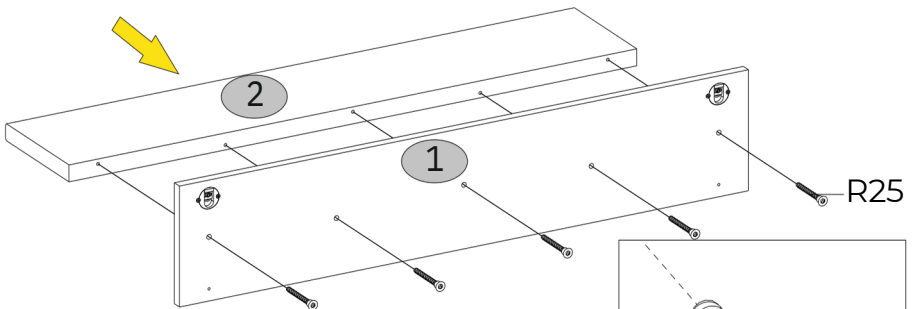
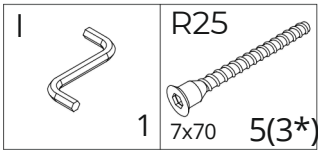

3

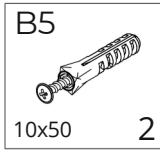

max.
3 kg

