

Instructions for assembling furniture

Instrukcja montażu mebli

Collection Kolecja mebli

«DIESEL»

AH-029.47.00.00

Chest of drawers 4S

Komoda 4S

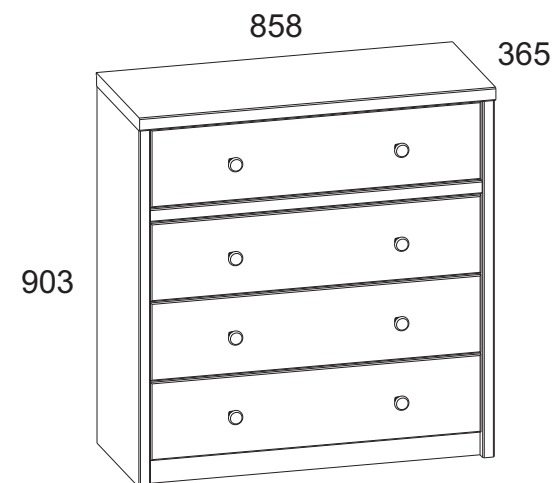

Production date
Data produkcji

Stamp of Quality Department
Pieczęć Działu Jakości

Przy eksploatacji mebli zabrania się:

- ustawiać meble w pobliżu grzewczych przyrządów i obok wilgotnych ścian, a także w pomieszczeniach ze względną wilgotnością więcej niż 70%;
- temperatura nagrzewania elementów mebli nie może przekraczać +40°C;
- w trakcie montażu i eksploatacji mebli stawać nogami na poziome panele i witryny;
- stosować chemiczne środki czyszczące do sprzątania mebli;

Gwarancje producenta

1. Gwarancyjny termin eksploatacji wyrobu - 24 miesiące z dnia sprzedaży. W okresie gwarancyjnego terminu producent gwarantuje naprawę wyrobów lub ich zamianę, jeżeli reguły eksploatacji nie zostały naruszone przez nabywcę.
2. Roszczenia są przekazywane przez nabywcę bezpośrednio do handlującej organizacji, w której były nabyte meble, tylko przy okazaniu danej "Instrukcji montażu" wraz z dokumentem zakupu.
3. Wyrób **Komoda 4S**, wchodzący w zestaw mebli **"DIESEL"**, odpowiada wymaganiom Norm Państwowych 16371-93, TPTC 025/2012
4. Trwałość użytkowa mebli - 10 lat.
5. Firma-producent pozostawia za sobą prawo do wprowadzania zmian w konstrukcje wyrobów, nie pogarszając ich konstruktywne i eksploatacyjne charakterystyki.
6. Do montażu wyrobów zaleca się skorzystanie z pomocy wykwalifikowanych specjalistów.

Ważne! Proszę zachować instrukcję w razie ponownego montażu mebli lub reklamacji. Podczas składania reklamacji prosimy o korzystanie z oznaczeń z instrukcji.

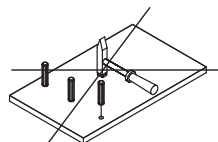
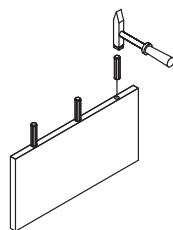
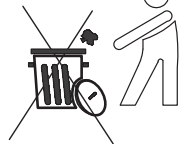
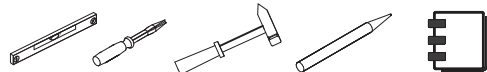

Instruction manual.

It's advised to check the quality and completeness of the product in the store when buying unpacked. Assembling of the product should be done the way it's described in this manual. While the product is in service loose screw connections should be periodically tightened. If it's necessary to move items around the apartment before moving you should release the product completely from the load (the mattress). To prevent damage to existing supports the product should be lifted before moving. Dusting the product should be done with a slightly damp soft cloth. To prevent warping of parts and discoloration of products do not install furniture in direct sunlight.

While the product is in service it's **PROHIBITED TO:**

- Install furniture near heating devices, close to the raw walls and in rooms with a relative humidity of more than 70%;
- heat elements of furniture to the temperature higher 40 C;
- step on the horizontal shields and windows during assembly and use of the products set;
- use chemical cleaners for cleaning furniture;

Manufacturer's warranty.

1. The warranty period of use of the product - 24 months from the date of sale. During the warranty period the manufacturer guarantees repair or replacement of products, if the user has not violated operating rules.
 2. Claims should be made by the consumer directly to the trading organization, in which furniture was purchased, presenting the "Instruction manual" and a copy of the sales receipt.
 3. The product, **Chest of drawers 4S**, which is part of a set of **«DIESEL»**, meets the requirements of GOST 16371-93, TR TS 025/2012.
 4. The lifetime of furniture - 10 years.
 5. The manufacturer reserves the right to make changes in product design, without compromising its design and application requirements.
 6. To assemble the products it's recommended to attract qualified personnel.
- It is important!** Keep the instruction in case of reassembly of furniture or complaint. When making a claim use the notation from the instruction.

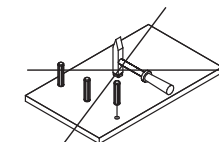
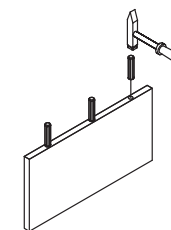
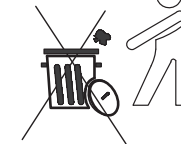
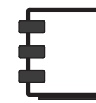
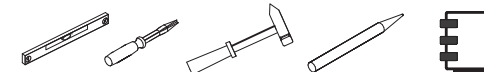









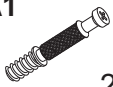

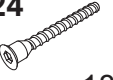





№ эл-та	Длина мм.	Ширина мм.	Толщина мм.	Кол-во шт.	№ пачки
13	858	365	32	1	1/2
113	867	355	28	1	1/2
114	867	355	28	1	1/2
135	800	60	16	1	1/2
136	800	60	16	1	1/2
140	800	60	32	1	1/2
159	796	190	16	3	2/2
159*	796	190	16	1	1/1
176	320	100	16	4	1/2
177	320	100	16	4	1/2
189	742	100	16	4	1/2
252	800	60	16	1	1/2
293	830	850	2,5	1	2/2
314	772	325	2,5	4	2/2

*Существует возможность заказа фасадов в разных цветовых версиях.

*There is an option of ordering fronts in various colours.

*Jest opcja zamówienia frontów w różnych kolorach.

A1  26	A2  26	S5  16
R24  7x50 18	G  1,5x26 22	B5  10x50 1
I  1	C1  8x35 26	N1  4
H23  8	M4  M4x22 8	L1  320 4
Z10  300 4	R27  5,0x13 40	Ri2  3,5x16 8
S6  1	R3  3x20 40	

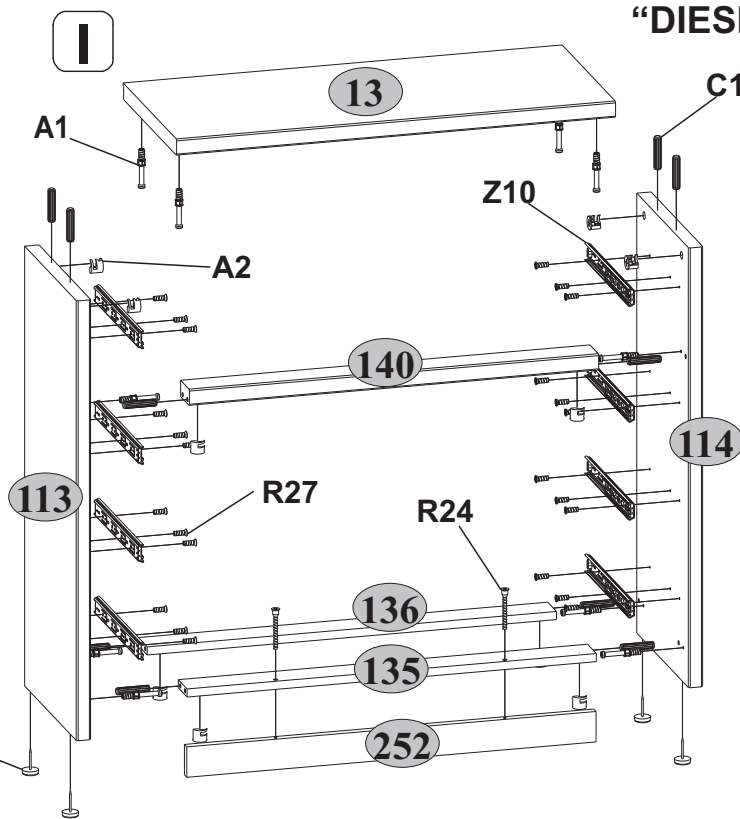
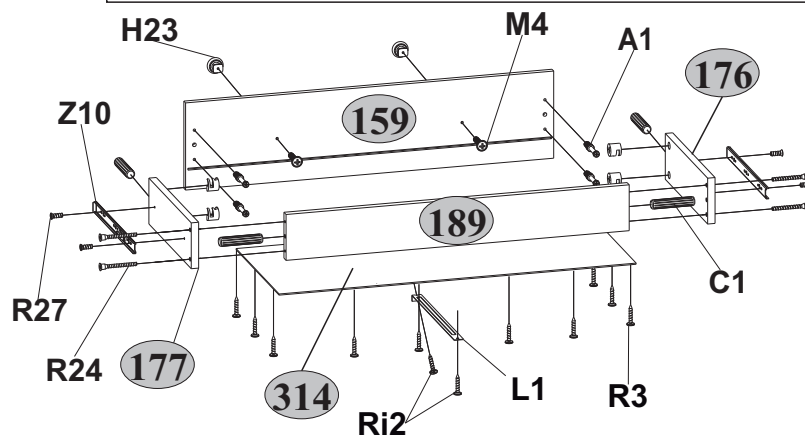
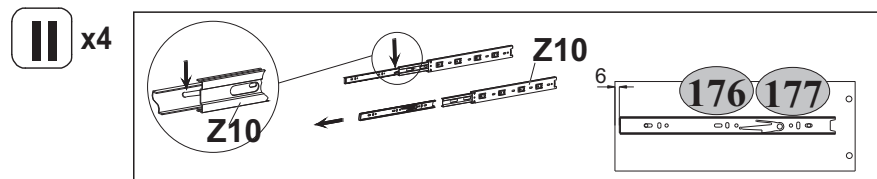

“DIESEL” Chest of drawers 4S Komoda 4S

