

# Instructions for assembling furniture

## Instrukcja montażu mebli

Collection Kolecja mebli

«DIESEL»

**Corner cabinet 2D**  
**Szafa narożna 2D**

AH-029.21.00.00

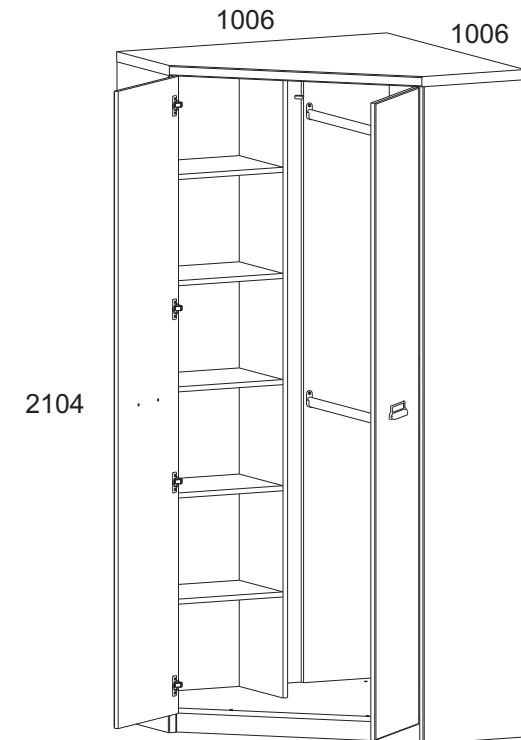

---

Production date  
Data produkcji

---

Stamp of Quality Department  
Pieczęć Działu Jakości

### Przy eksploatacji mebli zabrania się:

- ustawiać meble w pobliżu grzewczych przyrządów i obok wilgotnych ścian, a także w pomieszczeniach ze względną wilgotnością więcej niż 70%;
- temperatura nagrzewania elementów mebli nie może przekraczać +40°C;
- w trakcie montażu i eksploatacji mebli stawać nogami na poziome panele i witryny;
- stosować chemiczne środki czyszczące do sprzątania mebli;

### Gwarancje producenta

1. Gwarancyjny termin eksploatacji wyrobu - 24 miesiące z dnia sprzedaży. W okresie gwarancyjnego terminu producent gwarantuje naprawę wyrobów lub ich zamianę, jeżeli reguły eksploatacji nie zostały naruszone przez nabywcę.
2. Roszczenia są przekazywane przez nabywcę bezpośrednio do handlującej organizacji, w której były nabyte meble, tylko przy okazaniu danej "Instrukcji montażu" wraz z dokumentem zakupu.
3. Wyrób **Szafa narożna 2D**, wchodzący w zestaw mebli **"DIESEL"**, odpowiada wymaganiom Norm Państwowych 16371-93, TPTC 025/2012
4. Trwałość użytkowa mebli - 10 lat.
5. Firma-producent pozostawia za sobą prawo do wprowadzania zmian w konstrukcje wyrobów, nie pogarszając ich konstruktywne i eksploatacyjne charakterystyki.
6. Do montażu wyrobów zaleca się skorzystanie z pomocy wykwalifikowanych specjalistów.

**Ważne!** Proszę zachować instrukcję w razie ponownego montażu mebli lub reklamacji. Podczas składania reklamacji prosimy o korzystanie z oznaczeń z instrukcji.

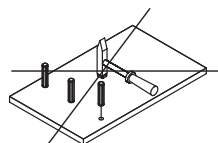
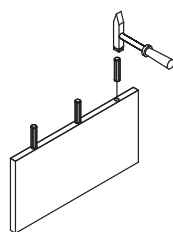
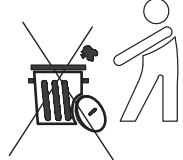

### Instruction manual.

It's advised to check the quality and completeness of the product in the store when buying unpacked. Assembling of the product should be done the way it's described in this manual. While the product is in service loose screw connections should be periodically tightened. If it's necessary to move items around the apartment before moving you should release the product completely from the load (the mattress). To prevent damage to existing supports the product should be lifted before moving. Dusting the product should be done with a slightly damp soft cloth. To prevent warping of parts and discoloration of products do not install furniture in direct sunlight.

### While the product is in service it's **PROHIBITED TO:**

- Install furniture near heating devices, close to the raw walls and in rooms with a relative humidity of more than 70%;
- heat elements of furniture to the temperature higher 40 C;
- step on the horizontal shields and windows during assembly and use of the products set;
- use chemical cleaners for cleaning furniture;

### Manufacturer's warranty.

1. The warranty period of use of the product - 24 months from the date of sale. During the warranty period the manufacturer guarantees repair or replacement of products, if the user has not violated operating rules.
  2. Claims should be made by the consumer directly to the trading organization, in which furniture was purchased, presenting the "Instruction manual" and a copy of the sales receipt.
  3. The product, **Corner cabinet 2D**, which is part of a set of **«DIESEL»**, meets the requirements of GOST 16371-93, TR TS 025/2012.
  4. The lifetime of furniture - 10 years.
  5. The manufacturer reserves the right to make changes in product design, without compromising its design and application requirements.
  6. To assemble the products it's recommended to attract qualified personnel.
- It is important!** Keep the instruction in case of reassembly of furniture or complaint. When making a claim use the notation from the instruction.

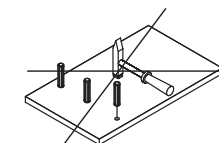
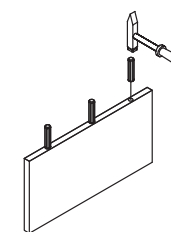
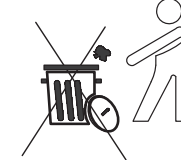
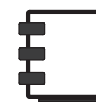

№ п/п	Длина мм.	Ширина мм.	Толщина мм.	Кол-во шт.	№ пачки
7	1006	1006	32	1	1/4
55	400	300	16	5	1/4
56	977	977	16	1	1/4
105	2068	355	28	1	2/4
106	2068	355	28	1	2/4
139	961	100	16	1	1/4
144	1992	300	16	1	3/4
145	1992	300	16	1	3/4
215	438	2005	16	2	3/4
254	886	60	16	1	1/4
255	100	60	16	1	1/4
291	2034	727	2,5	1	4/4
292	2034	1000	2,5	1	4/4
Y2	953			2	1/4

Corner cabinet 2D  
«DIESEL»  
Szafa narożna 2D

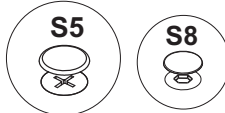
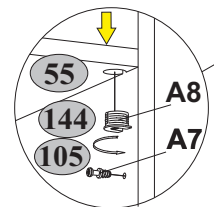
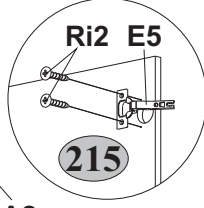
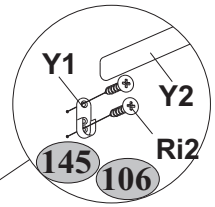
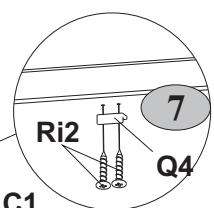
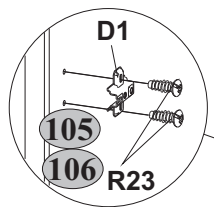
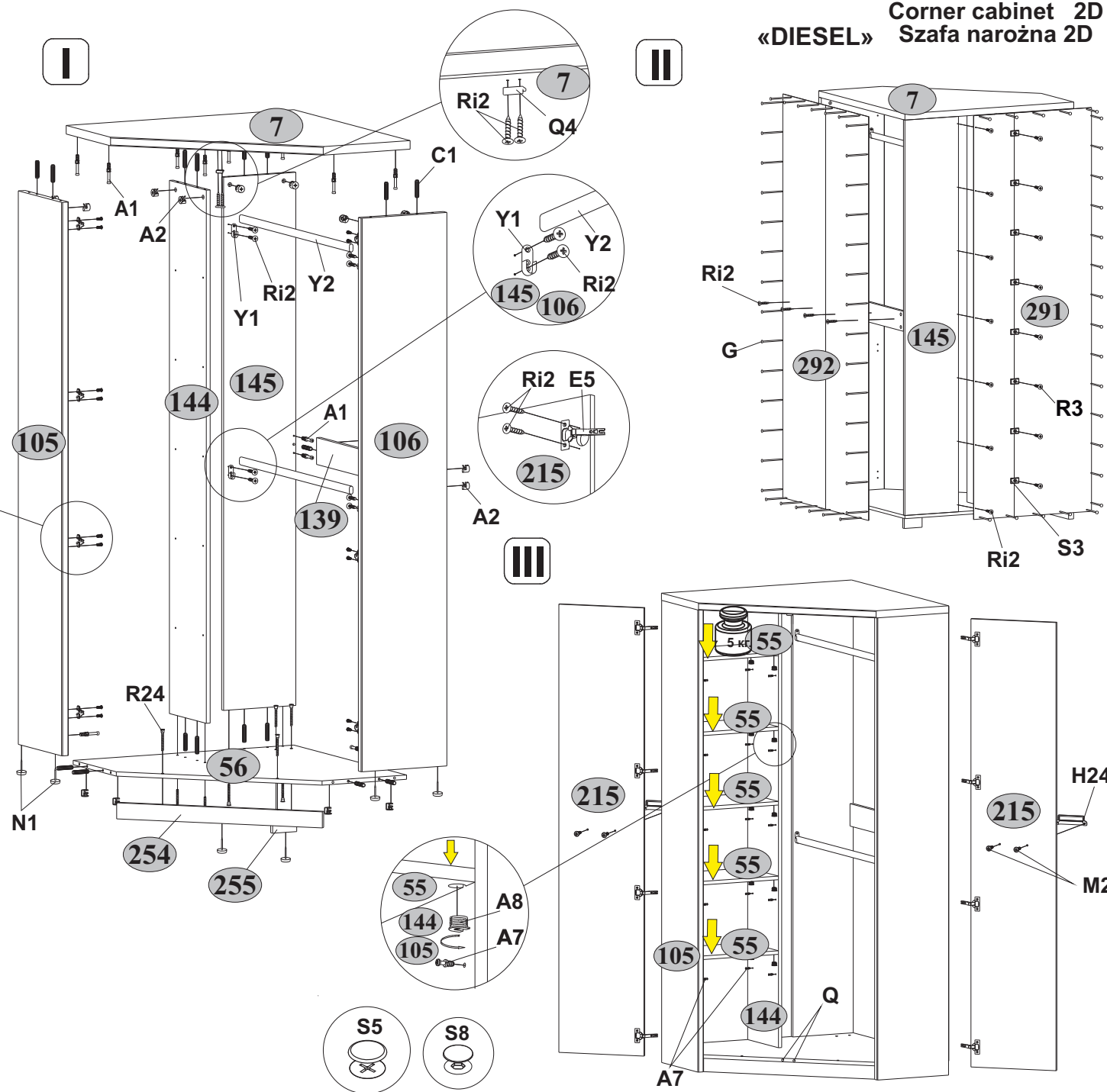

<b>A1</b>  16	<b>A2</b>  16	<b>S5</b>  8	<b>S8</b>  4
<b>R24</b>  7x50 8	<b>G</b>  1,5x26 60	<b>S3</b>  8	<b>Q</b>  2
<b>I</b>  1	<b>C1</b>  8x35 18	<b>N1</b>  6	<b>E5</b>  8
	<b>H24</b>  2	<b>Y1</b>  4	<b>D1</b>  8
<b>A7</b>  20	<b>M2</b>  M4x16	<b>Ri2</b>  4 3,5x16	<b>R23</b>  6,3x13 16
<b>A8</b>  20		<b>R3</b>  3x20 8	<b>Q4</b>  1